

SIRUBA®

銀爺牌工業用縫紉機

INDUSTRIAL SEWING MACHINE

700K

零件圖 PARTS LIST



CE











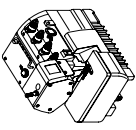

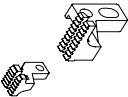
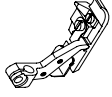

高林股份有限公司
KAULIN MFG. CO., LTD.

| 機 型 MODEL | 針板 NEEDLE PLATE | 送具 FEED DOG | 送具 FEED DOG | 送具 FEED DOG | 押具 PRESSER FOOT | 勾針 LOOPER | 針留 NEEDLE CLAMP | 束子 COLLER | 衝程 CRANK | 衝程 CRANK | 大心 Crankshaft | 勾針連桿座 Upper Looper Holder | 過線器 Bracket | 下刀架 Lower Knife Holder | 針 號 NEEDLE |
|-----------------------|-----------------------|-------------------|-------------------|-------------------|-----------------------|--------------|-----------------------|--------------|-------------|-------------|------------------|---------------------------------|----------------|------------------------------|---------------|
| 737K-504F1-04 | E206 | D201 | D207 | H201 | P201-4A | LP225 | KG231K-E | KJ204 | KF203-E | KJ206-E | KD201 | KJ236 | KJ219 | KR209 | DC27#9 |
| 737K-504M1-15 | E207 | D201 | D209 | H201 | P211-A | LP225 | KG231K-E | KJ204 | KF203-E | KJ206-E | KD201 | KJ236 | KJ219 | KR209 | DC27#9 |
| 737K-504M1-15VT | E207 | D201 | D209 | H201 | P211-A | LP225 | KG231K-E | KJ204 | KF203-E | KJ206-E | KD201 | KJ236 | KJ219 | KR209 | DC27#9 |
| 737K-504M2-04 | E222 | D210 | D207 | H204 | P201-A | LP225 | KG231K-E | KJ204 | KF203-E | KJ206-E | KD201 | KJ236 | KJ219 | KR209 | DC27#11 |
| 737K-504M2-04CT | E222 | D210 | D207 | H204 | P201-A | LP225 | KG231K-E | KJ204 | KF203-E | KJ206-E | KD201 | KJ236 | KJ219 | KR209 | DC27#11 |
| 737K-504M2-04EC | E222 | D210 | D207 | H204 | P201-A | LP225 | KG231K-E | KJ204 | KF203-E | KJ206-E | KD201 | KJ236 | KJ219 | KR209 | DC27#11 |
| 737K-504M2-04LFC-2 | E222 | D210 | D207 | H204 | P215-A | LP225 | KG231K-E | KJ204 | KF203-E | KJ206-E | KD201 | KJ236 | KJ219 | KR209 | DC27#11 |
| 737K-504M2-04LFC-2/EC | E222 | D210 | D207 | H204 | P215-A | LP225 | KG231K-E | KJ204 | KF203-E | KJ206-E | KD201 | KJ236 | KJ219 | KR209 | DC27#11 |
| 737K-504M2-04TR | E231 | D210 | D214 | H204 | P215-A | LP225 | KG231K-E | KJ204 | KF203-E | KJ206-E | KD201 | KJ236 | KJ219 | KR209 | DC27#11 |
| 737K-504M2-04TR/EC | E231 | D210 | D214 | H204 | P215-A | LP225 | KG231K-E | KJ204 | KF203-E | KJ206-E | KD201 | KJ236 | KJ219 | KR209 | DC27#11 |
| 737K-504M2-04VT | E222 | D210 | D207 | H204 | P201-A | LP225 | KG231K-E | KJ204 | KF203-E | KJ206-E | KD201 | KJ236 | KJ219 | KR209 | DC27#11 |
| 737K-504M2-04WR/LF-B | E231 | | | | | LP225 | KG231K-E | KJ204 | KF203-E | KJ206-E | KD201 | KJ236 | KJ219 | KR209 | DC27#11 |
| 737K-504M3-04 | E220 | D210 | D209 | H204 | P201-A | LP225 | KG231K-E | KJ204 | KF203-E | KJ206-E | KD201 | KJ236 | KJ219 | KR209 | DC27#11 |
| 737K-504M3-05 | E221 | D210 | D209 | H204 | P201-A | LP225 | KG231K-E | KJ204 | KF203-E | KJ206-E | KD201 | KJ236 | KJ219 | KR209 | DC27#11 |
| 737K-504M3-05CT | E221 | D210 | D209 | H204 | P201-A | LP225 | KG231K-E | KJ204 | KF203-E | KJ206-E | KD201 | KJ236 | KJ219 | KR209 | DC27#11 |
| 737K-504M3-05PZ | E221 | D210 | D209 | H204 | P216-A | LP225 | KG231K-E | KJ204 | KF203-E | KJ206-E | KD201 | KJ236 | KJ219 | KR209 | DC27#11 |
| 737K-504M3-05VT | E221 | D210 | D209 | H204 | P201-A | LP225 | KG231K-E | KJ204 | KF203-E | KJ206-E | KD201 | KJ236 | KJ219 | KR209 | DC27#11 |
| 737K-504M5-04BK | E232 | D210 | D207 | H203 | P202-A | LP225 | KG231K-E | KJ204 | KF203-E | KJ206-E | KD201 | KJ236 | KJ219 | KR209 | DC27#11 |
| 737K-504M5-04BK/VT | E232 | D210 | D207 | H203 | P202-A | LP225 | KG231K-E | KJ204 | KF203-E | KJ206-E | KD201 | KJ236 | KJ219 | KR209 | DC27#11 |
| 737K-504F1-15 | E207 | D201 | D209 | H201 | P203-A | LP225 | KG231K-E | KJ204 | KF203-E | KJ206-E | KD201 | KJ236 | KJ219 | KR209 | DC27#9 |
| 737K-505F1-04 | E206 | D201 | D207 | H201 | P203-A | LP225 | KG231K-E | KJ204 | KF203-E | KJ206-E | KD201 | KJ236 | KJ219 | KR209 | DC27#9 |
| 737K-505F1-04VT | E206 | D201 | D207 | H201 | P203-A | LP225 | KG231K-E | KJ204 | KF203-E | KJ206-E | KD201 | KJ236 | KJ219 | KR209 | DC27#9 |
| 747K-512M1-25 | E208 | D210 | D207 | H204 | P201-5A | LP228 | KG242K-E | KJ234+KL15 | KF215-E | KJ203-E | KD201 | KJ208 | KJ219 | KR209 | DC27#11*2 |
| 747K-512M1-25CT | E208 | D210 | D207 | H204 | P201-5A | LP228 | KG242K-E | KJ234+KL15 | KF215-E | KJ203-E | KD201 | KJ208 | KJ219 | KR209 | DC27#11*2 |
| 747K-512M1-34 | E236 | D210 | D207 | H204 | P221-A | LP226 | KG243K-E | KJ234+KL15 | KF203-E | KJ203-E | KD201 | KJ208 | KJ219 | KR209 | DC27#14*2 |
| 747K-514F1-24 | E212 | D210 | D207 | H204 | P201-3A | LP229 | KG242K-E | KJ204 | KF203-E | KJ206-E | KD201 | KJ236 | KJ219 | KR209 | DC27#11*2 |
| 747K-514H4-24CA | E229 | D202 | D207 | H202 | P204-A | LP226 | KG242K-E | KJ234+KL15 | KF203-E | KJ203-E | KD201 | KJ208 | KJ219 | KR209 | DC27#11*2 |
| 747K-514H4-24CA/CT | E229 | D202 | D207 | H202 | P204-A | LP226 | KG242K-E | KJ234+KL15 | KF203-E | KJ203-E | KD201 | KJ208 | KJ219 | KR209 | DC27#11*2 |
| 747K-514H4-24GA/EC | E229 | D202 | D207 | H202 | P204-A | LP226 | KG242K-E | KJ234+KL15 | KF203-E | KJ203-E | KD201 | KJ208 | KJ219 | KR209 | DC27#11*2 |
| 747K-514H4-24GA/P | E229 | D202 | D207 | H202 | P204-A | LP226 | KG242K-E | KJ234+KL15 | KF203-E | KJ203-E | KD201 | KJ208 | KJ219 | KR209 | DC27#11*2 |
| 747K-514M2-24 | E229 | D210 | D207 | H204 | P201-A | LP226 | KG242K-E | KJ234+KL15 | KF203-E | KJ203-E | KD201 | KJ208 | KJ219 | KR209 | DC27#11*2 |
| 747K-514M2-24CT | E229 | D210 | D207 | H204 | P201-A | LP226 | KG242K-E | KJ234+KL15 | KF203-E | KJ203-E | KD201 | KJ208 | KJ219 | KR209 | DC27#11*2 |
| 747K-514M2-24EC | E229 | D210 | D207 | H204 | P201-A | LP226 | KG242K-E | KJ234+KL15 | KF203-E | KJ203-E | KD201 | KJ208 | KJ219 | KR209 | DC27#11*2 |

規格件表 CONVERSION CHART

規格件表 CONVERSION CHART

| | | | | | | | | | | | | |
|---|---|---|---|---|---|--|---|---|---|---|---|---|
|  |  |  |  |  |  |  |  |  |  |  |  |  |
| 機 型 MODEL | 針板 NEEDLE PLATE | 送具 FEED DOG | 押具 PRESSER FOOT | 勾 針 LOOPER | 針留 NEEDLE CLAMP | 束 子 COLLER | 衝 程 CRANK | 衝 程 CRANK | 勾針連焊座 Upper Looper Holder | 過線器 Bracket | 下刀架 Lower Knife Holder | 針 號 NEEDLE |
| 747K-514M2-24LFC-2 | E229 | D210 | P216-A | LP225 | KG242K-E | KJ234+KLL15 | KF203-E | KF203-E | KJ208 | KJ219 | KR209 | DC27#11*2 |
| 747K-514M2-24LFC-2/EC | E229 | D210 | P216-A | LP226 | KG242K-E | KJ234+KLL15 | KF203-E | KF203-E | KJ208 | KJ219 | KR209 | DC27#11*2 |
| 747K-514M2-24TG | E229 | D210 | P201-A | LP226 | KG242K-E | KJ234+KLL15 | KF203-E | KF203-E | KJ208 | KJ219 | KR209 | DC27#11*2 |
| 747K-514M2-24TG/EC | E229 | D210 | P201-A | LP226 | KG242K-E | KJ234+KLL15 | KF203-E | KF203-E | KJ208 | KJ219 | KR209 | DC27#11*2 |
| 747K-514M2-24VT | E229 | D210 | P201-A | LP226 | KG242K-E | KJ234+KLL15 | KF203-E | KF203-E | KJ208 | KJ219 | KR209 | DC27#11*2 |
| 747K-514M2-25 | E208 | D210 | P201-A | LP226 | KG242K-E | KJ234+KLL15 | KF203-E | KF203-E | KJ208 | KJ219 | KR209 | DC27#11*2 |
| 747K-514M2-25CT | E208 | D210 | P201-A | LP226 | KG242K-E | KJ234+KLL15 | KF203-E | KF203-E | KJ208 | KJ219 | KR209 | DC27#11*2 |
| 747K-514M2-25TG | E208 | D210 | P201-A | LP226 | KG242K-E | KJ234+KLL15 | KF203-E | KF203-E | KJ208 | KJ219 | KR209 | DC27#11*2 |
| 747K-514M4-23 | E209 | D210 | P201-2A | LP226 | KG242K-E | KJ234+KLL15 | KF203-E | KF203-E | KJ208 | KJ219 | KR209 | DC27#11*2 |
| 747K-514M4-23/CT | E209 | D210 | P201-2A | LP226 | KG242K-E | KJ234+KLL15 | KF203-E | KF203-E | KJ208 | KJ219 | KR209 | DC27#11*2 |
| 747K-514M5-23BK | E210 | D203 | P202-A | LP226 | KG242K-E | KJ234+KLL15 | KF203-E | KF203-E | KJ208 | KJ219 | KR209 | DC27#11*2 |
| 747K-514M5-23BK/VT | E210 | D203 | P202-A | LP226 | KG242K-E | KJ234+KLL15 | KF203-E | KF203-E | KJ208 | KJ219 | KR209 | DC27#11*2 |
| 747K-514M7-23 | E242 | D218 | P201-5A | LP227 | KG242K-E | KJ234+KLL15 | KF203-E | KF203-E | KJ228 | KJ238 | KR209 | DC27#16*2 |
| 747K-514M7-23/CT | E242 | D218 | P201-5A | LP227 | KG242K-E | KJ234+KLL15 | KF203-E | KF203-E | KJ228 | KJ238 | KR209 | DC27#16*2 |
| 747K-514M7-24 | E243 | D218 | P201-5A | LP227 | KG242K-E | KJ234+KLL15 | KF203-E | KF203-E | KJ228 | KJ238 | KR209 | DC27#16*2 |
| 747K-514M7-24CT | E243 | D218 | P201-5A | LP227 | KG242K-E | KJ234+KLL15 | KF203-E | KF203-E | KJ228 | KJ238 | KR209 | DC27#16*2 |
| 747K-514M7-24TG | E243 | D218 | P201-5A | LP227 | KG242K-E | KJ234+KLL15 | KF203-E | KF203-E | KJ228 | KJ238 | KR209 | DC27#16*2 |
| 747K-514M7-25 | E244 | D218 | P201-5A | LP227 | KG242K-E | KJ234+KLL15 | KF203-E | KF203-E | KJ228 | KJ238 | KR209 | DC27#16*2 |
| 747K-514M7-25/AN | E244 | D218 | P201-5A | LP227 | KG242K-E | KJ234+KLL15 | KF203-E | KF203-E | KJ228 | KJ238 | KR209 | DC27#16*2 |
| 747K-514M7-25BK | E210 | D203 | P202-A | LP227 | KG242K-E | KJ234+KLL15 | KF203-E | KF203-E | KJ228 | KJ238 | KR209 | DC27#16*2 |
| 747K-514M7-25BK/AN | E210 | D203 | P202-A | LP227 | KG242K-E | KJ234+KLL15 | KF203-E | KF203-E | KJ228 | KJ238 | KR209 | DC27#16*2 |
| 747K-514M7-25CT | E244 | D218 | P201-5A | LP227 | KG242K-E | KJ234+KLL15 | KF203-E | KF203-E | KJ228 | KJ238 | KR209 | DC27#16*2 |
| 747K-514M7-25TG | E244 | D218 | P201-5A | LP227 | KG242K-E | KJ234+KLL15 | KF203-E | KF203-E | KJ228 | KJ238 | KR209 | DC27#16*2 |
| 747K-514M7-25TG/AN | E244 | D218 | P201-5A | LP227 | KG242K-E | KJ234+KLL15 | KF203-E | KF203-E | KJ228 | KJ238 | KR209 | DC27#16*2 |
| 747K-514M8-35 | E223 | D212 | P214-A | LP229 | KG254K-E | KJ234+KLL15 | KF203-E | KF203-E | KJ228 | KJ238 | KR211 | DC27#18*2 |
| 747K-514M8-35CT | E223 | D212 | P214-A | LP229 | KG254K-E | KJ234+KLL15 | KF203-E | KF203-E | KJ228 | KJ238 | KR211 | DC27#18*2 |
| 757K-401M1/TW | E237 | D212 | P215-A | LP226 | KG242K-E | KJ204 | KF203-E | KF203-E | KJ208 | KJ219 | KR219 | DC27#14*2 |
| 757K-401M1/TW/CT | E237 | | P215-A | LP226 | KG253K-E | KJ204 | KF203-E | KF203-E | KJ236 | KJ219 | KR219 | DC27#14*2 |
| 757K-401M2-50TA | E238 | D211 | P223-A | LP226 | KG256K-E | KJ204 | KF203-E | KF203-E | KJ236 | KJ219 | KR219 | DC27#14*2 |
| 757K-401M2-50TA/EC | E238 | D211 | P223-A | LP226 | KG256K-E | KJ204 | KF203-E | KF203-E | KJ236 | KJ219 | KR219 | DC27#14*2 |
| 757K-516H4-35GA | E213 | D204 | P508J-A | LP226 | KG253K-E | KJ204 | KF203-E | KF203-E | KJ236 | KJ219 | KR219 | DC27#14*2 |
| 757K-516H4-35GA/EC | E213 | D204 | P508J-A | LP226 | KG253K-E | KJ204 | KF203-E | KF203-E | KJ236 | KJ219 | KR219 | DC27#14*2 |
| 757K-516H4-35GA/P | E213 | D204 | P508J-A | LP226 | KG253K-E | KJ204 | KF203-E | KF203-E | KJ236 | KJ219 | KR219 | DC27#14*2 |

| 機 型 MODEL | 針板 NEEDLE PLATE | 送具 FEED DOG | 送具 FEED DOG | 送具 FEED DOG | 押具 PRESSER FOOT | 勾針 LOOPER | 針留 NEEDLE CLAMP | 束子 COLLER | 衝程 CRANK | 衝程 CRANK | 大心 Crankshaft | 勾針連焊座 Upper Looper Holder | 過線器 Bracket | 下刀架 Lower Knife Holder | 針號 NEEDLE |
|----------------------|-----------------------|-------------------|-------------------|-------------------|-----------------------|--------------|-----------------------|--------------|-------------|-------------|------------------|---------------------------------|----------------|------------------------------|--------------|
| 757K-516H4-35GA/P/EC | E213 | D204 | D207 | H205 | P508J-A | LP226 | KG253K-E | KJ204 | KF203-E | KJ206-E | KD201 | KJ236 | KJ219 | KR219 | DC27#14*2 |
| 757K-516H4-55GA | E214 | D205 | D207 | H206 | P509J-A | LP226 | KG255K-E | KJ204 | KF203-E | KJ206-E | KD201 | KJ236 | KJ219 | KR219 | DC27#14*2 |
| 757K-516H4-55GA/EC | E214 | D205 | D207 | H206 | P509J-A | LP226 | KG255K-E | KJ204 | KF203-E | KJ206-E | KD201 | KJ236 | KJ219 | KR219 | DC27#14*2 |
| 757K-516H4-55GA/P | E214 | D205 | D207 | H206 | P509J-A | LP226 | KG255K-E | KJ204 | KF203-E | KJ206-E | KD201 | KJ236 | KJ219 | KR219 | DC27#14*2 |
| 757K-516H4-55GA/P/EC | E214 | D205 | D207 | H206 | P509J-A | LP226 | KG255K-E | KJ204 | KF203-E | KJ206-E | KD201 | KJ236 | KJ219 | KR219 | DC27#14*2 |
| 757K-516L1-24 | E215 | D206 | D207 | H207 | P500J-A | LP225 | KG252K-E | KJ204 | KF203-E | KJ206-E | KD201 | KJ236 | KJ219 | KR219 | DC27#14*2 |
| 757K-516L1-35 | E215 | D206 | D207 | H207 | P500J-A | LP225 | KG252K-E | KJ204 | KF203-E | KJ206-E | KD201 | KJ236 | KJ219 | KR219 | DC27#14*2 |
| 757K-516L1-35CT | E216 | D206 | D207 | H212 | P504J-A | LP225 | KG253K-E | KJ204 | KF203-E | KJ206-E | KD201 | KJ236 | KJ219 | KR219 | DC27#14*2 |
| 757K-516M2-35 | E216 | D206 | D207 | H212 | P504J-A | LP225 | KG253K-E | KJ204 | KF203-E | KJ206-E | KD201 | KJ236 | KJ219 | KR219 | DC27#14*2 |
| 757K-516M2-35CT | E217 | D208 | D207 | H208 | P504J-A | LP226 | KG253K-E | KJ204 | KF203-E | KJ206-E | KD201 | KJ236 | KJ219 | KR219 | DC27#14*2 |
| 757K-516M2-35CT | E217 | D208 | D207 | H208 | P504J-A | LP226 | KG253K-E | KJ204 | KF203-E | KJ206-E | KD201 | KJ236 | KJ219 | KR219 | DC27#14*2 |
| 757K-516M2-35PS | E217 | D208 | D207 | H208 | P504J-A | LP226 | KG253K-E | KJ204 | KF203-E | KJ206-E | KD201 | KJ236 | KJ219 | KR219 | DC27#14*2 |
| 757K-516M2-35PS/EC | E217 | D208 | D207 | H208 | P504J-A | LP226 | KG253K-E | KJ204 | KF203-E | KJ206-E | KD201 | KJ236 | KJ219 | KR219 | DC27#14*2 |
| 757K-516M2-55 | E218 | D208 | D207 | H209 | P502J-A | LP226 | KG255K-E | KJ204 | KF203-E | KJ206-E | KD201 | KJ236 | KJ219 | KR219 | DC27#14*2 |
| 757K-516M2-55CT | E218 | D208 | D207 | H209 | P502J-A | LP226 | KG255K-E | KJ204 | KF203-E | KJ206-E | KD201 | KJ236 | KJ219 | KR219 | DC27#14*2 |
| 757K-516M2-55EC | E218 | D208 | D207 | H209 | P502J-A | LP226 | KG255K-E | KJ204 | KF203-E | KJ206-E | KD201 | KJ236 | KJ219 | KR219 | DC27#14*2 |
| 757K-516M2-55PS | E218 | D208 | D207 | H209 | P502J-A | LP226 | KG255K-E | KJ204 | KF203-E | KJ206-E | KD201 | KJ236 | KJ219 | KR219 | DC27#14*2 |
| 757K-516M2-55PS/EC | E218 | D208 | D207 | H209 | P502J-A | LP226 | KG255K-E | KJ204 | KF203-E | KJ206-E | KD201 | KJ236 | KJ219 | KR219 | DC27#14*2 |
| 767K-516M2-324 | E219 | D208 | D207 | H209 | P233J-A | LP226 | KG433K-E | KJ234+HL15 | KF203-E | KJ203-E | KD201 | KJ208 | KJ219 | KR219 | DC27#11*3 |
| 767K-516M2-324/CT | E219 | D208 | D207 | H209 | P233J-A | LP226 | KG433K-E | KJ234+HL15 | KF203-E | KJ203-E | KD201 | KJ208 | KJ219 | KR219 | DC27#11*3 |
| 767K-516M2-524 | E224 | D208 | D207 | H209 | P255J-A | LP226 | KG455K-E | KJ234+HL15 | KF203-E | KJ203-E | KD201 | KJ208 | KJ219 | KR219 | DC27#11*3 |
| 767K-516M2-524/CT | E224 | D208 | D207 | H209 | P255J-A | LP226 | KG455K-E | KJ234+HL15 | KF203-E | KJ203-E | KD201 | KJ208 | KJ219 | KR219 | DC27#11*3 |

規格件表 CONVERSION CHART

PARTS LIST FOR KA GROUP

PARTS LIST FOR KB GROUP

| | | |
|----------|---------|---------|
| MODEL | 3線 / 4線 | 5線 / 6線 |
| PARTS NO | KA224 | |

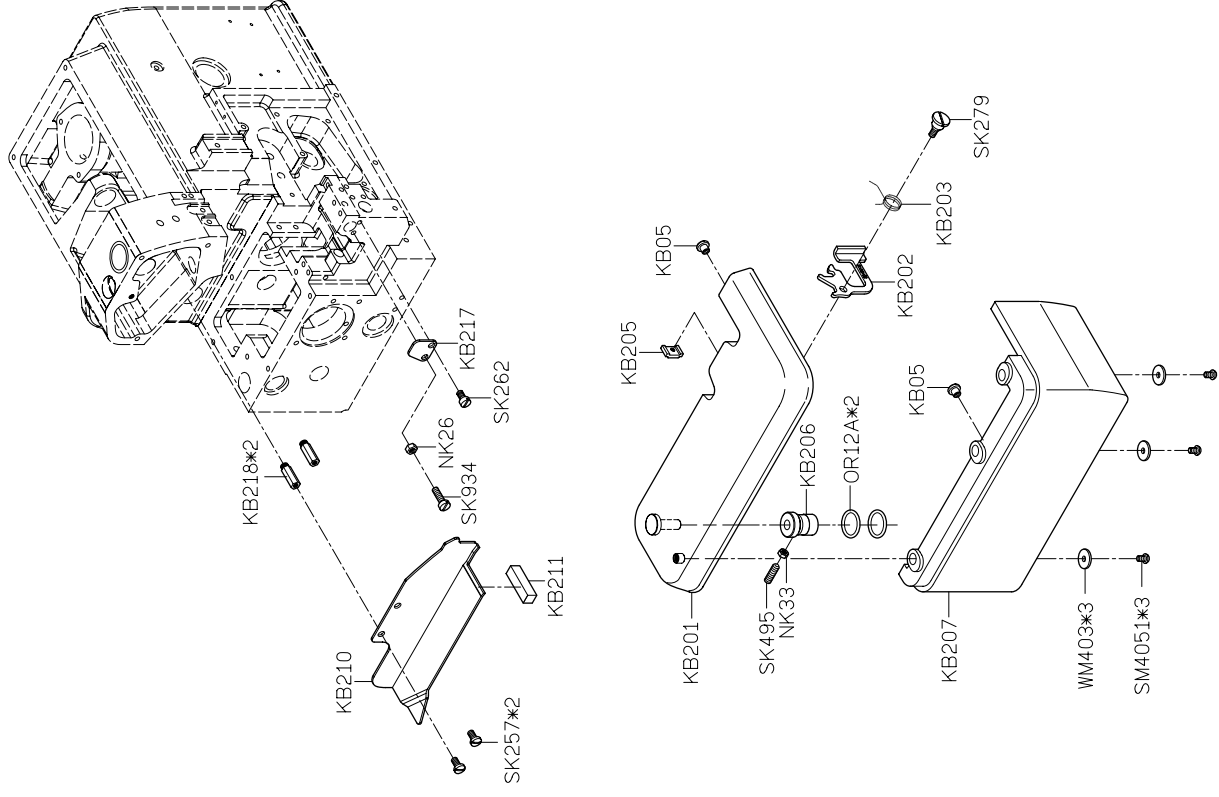
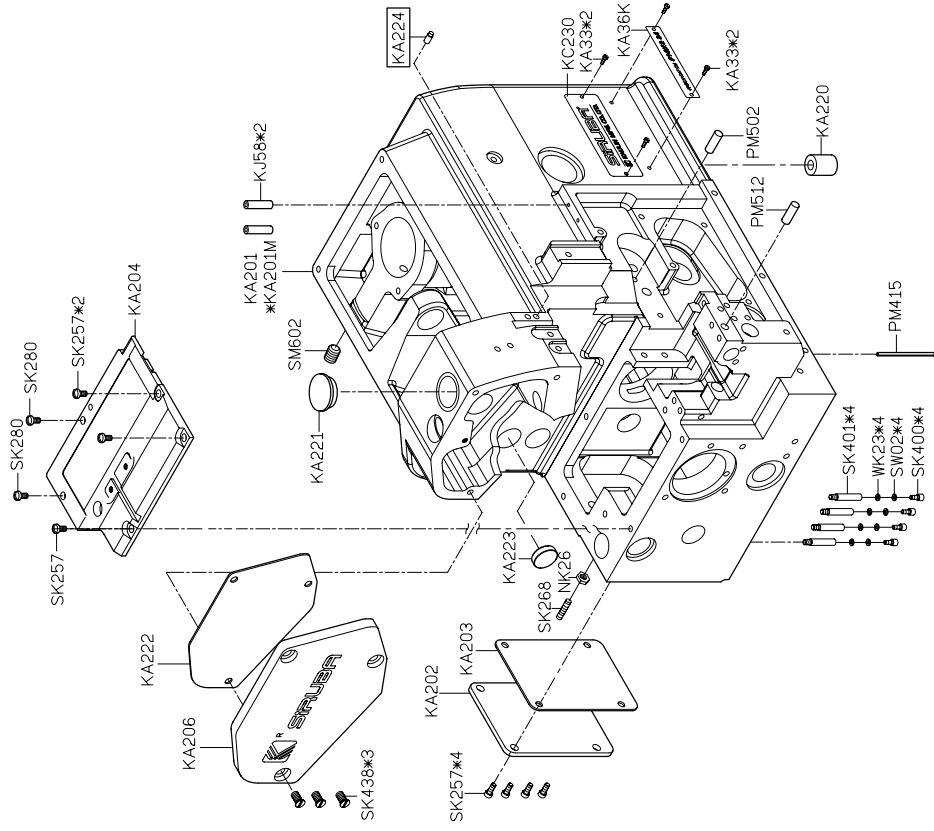

FOR 700K

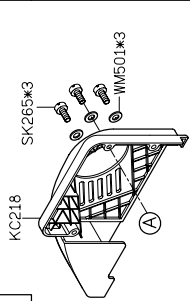

FOR 700KD

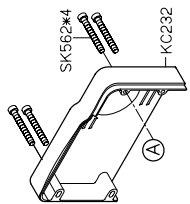

| | | |
|----------|-------|-------|
| MODEL | 3線/4線 | 5線/6線 |
| PARTS NO | KC209 | KC219 |

FOR 700K

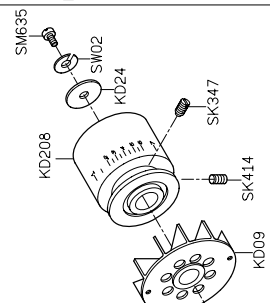

FOR 700KD

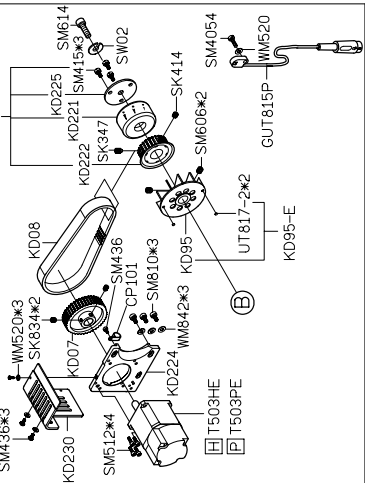

| | | |
|----------|-------|--------------------------------------|
| MODEL | 3線/4線 | 5線/6線 |
| PARTS NO | KD204 | KD217 KD220 SK339*2 SK245*1 |

FOR 700K

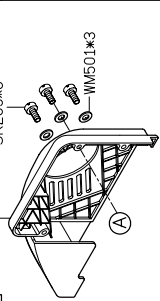

FOR 700KD

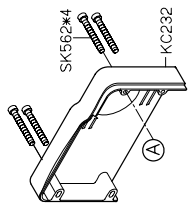

| | | |
|----------|-------|-------|
| MODEL | 3線/4線 | 5線/6線 |
| PARTS NO | KC209 | KC219 |

FOR 700K

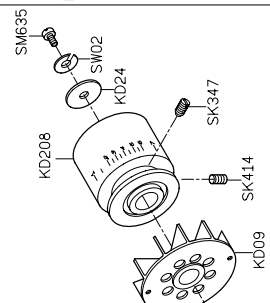

FOR 700KD

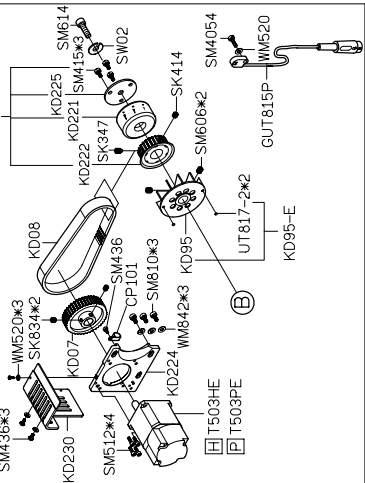

| | | |
|----------|-------|--------------------------------------|
| MODEL | 3線/4線 | 5線/6線 |
| PARTS NO | KD204 | KD217 KD220 SK339*2 SK245*1 |

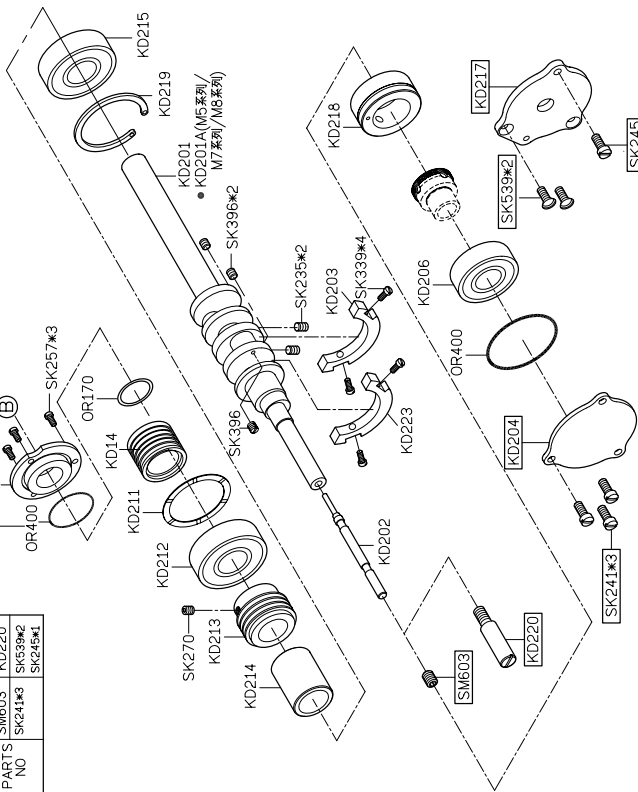

PARTS LIST FOR KC GROUP

PARTS LIST FOR KD GROUP

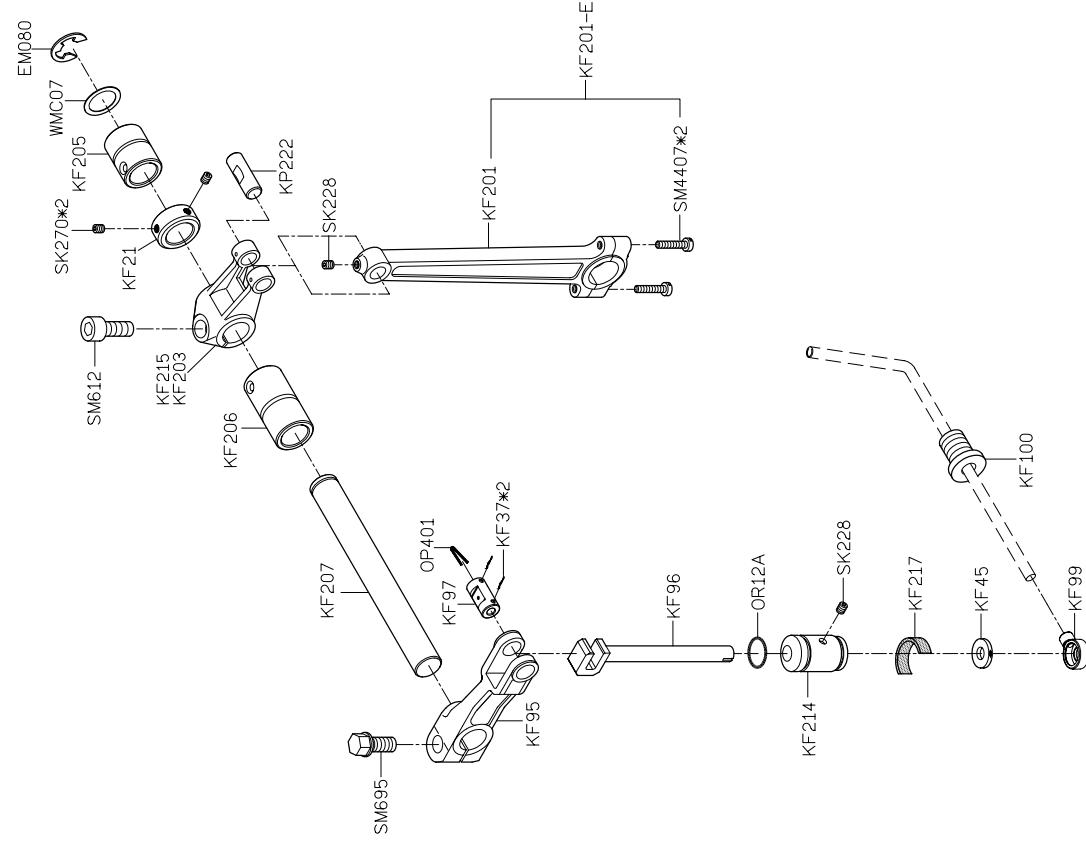

| MODEL | 3線 | 4線 | 5線 | 6線 |
|-------|--------|--------|---------|---------|
| | KG233 | KG211 | KG233 | KG247 |
| | KG248 | KG213 | KG236 | KG249 |
| | KG250 | KG221 | KG243 | KG245 |
| | KG222 | KG222 | KG245 | KG245 |
| | KG225 | KG225 | KG261 | KG261 |
| | KG220 | KG220 | KG220 | KG226 |
| | KG201 | KG201 | KG244 | KG244 |
| | KG93 | KG92 | KG94 | KG94 |
| | SK216 | SK216 | SK216*2 | SK216*2 |
| | SK250N | SK250N | SK250N | SK250N |
| | SK437N | SK437N | SK437 | SK437 |
| | SM251 | SM251 | SM250 | SM250 |
| | SM251 | SM251 | SM250 | SM250 |

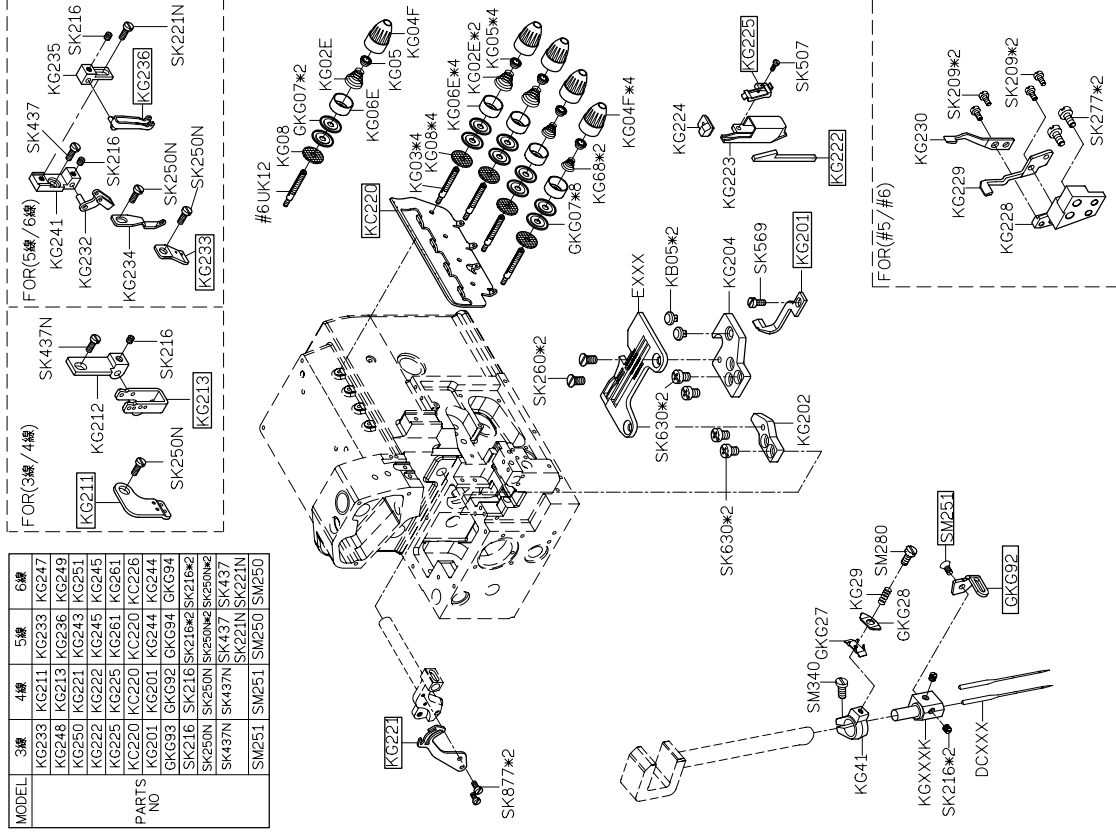

| MODEL | 3線/5線 | 4線/5線 | 4線/6線 |
|----------|-------|------------|------------|
| PARTS NO | KJ204 | KJ234+KL15 | KJ234+KL15 |
| | KJ206 | KJ203 | KJ203 |
| | KJ236 | KJ208 | KJ208 |

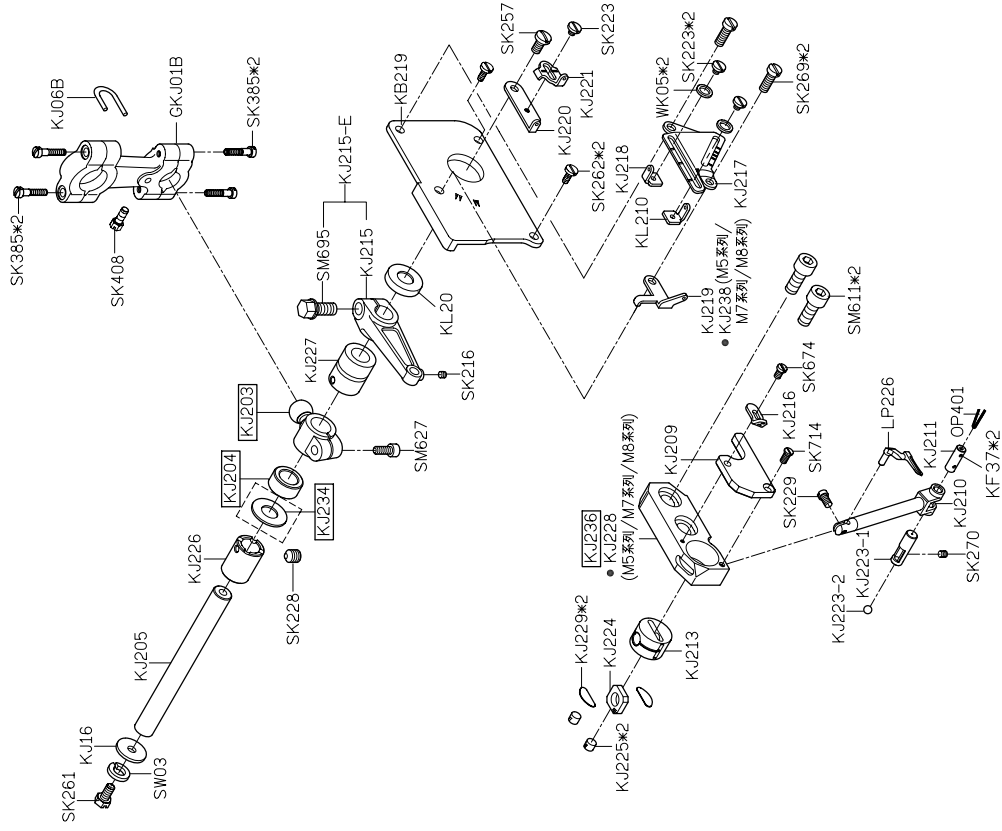

| MODEL | 3線/4線 | 5線/6線 |
|----------|-------|-------|
| PARTS NO | KL205 | KL209 |
| | | SK270 |

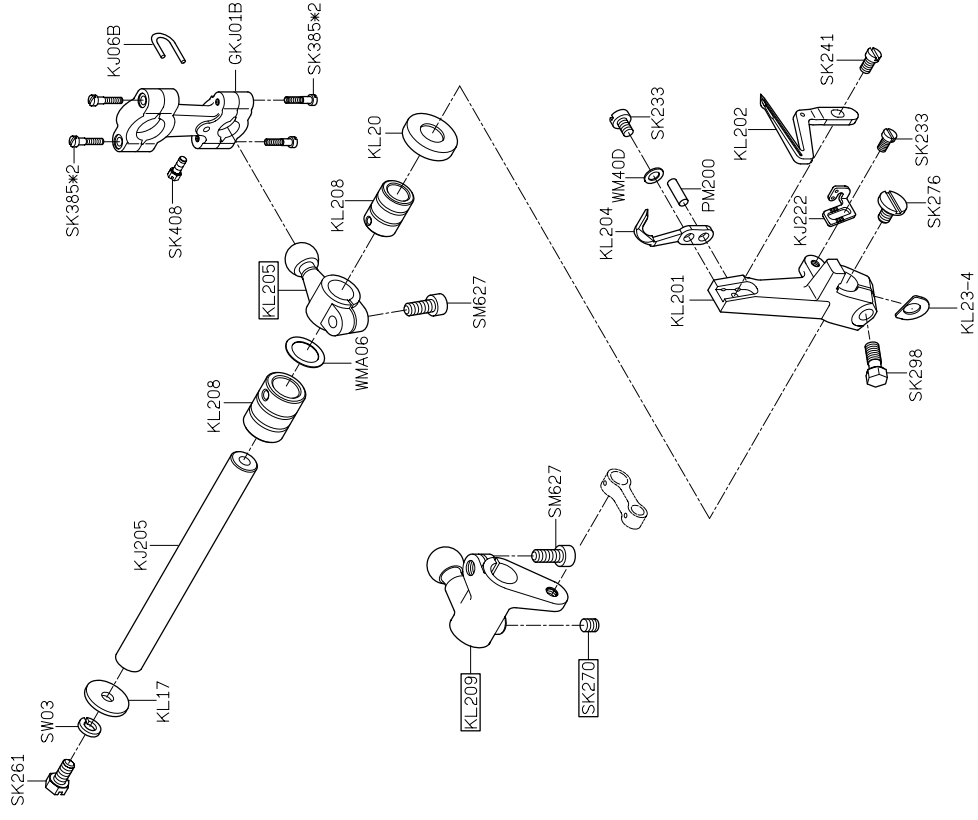

PARTS LIST FOR KM GROUP

PARTS LIST FOR KN GROUP

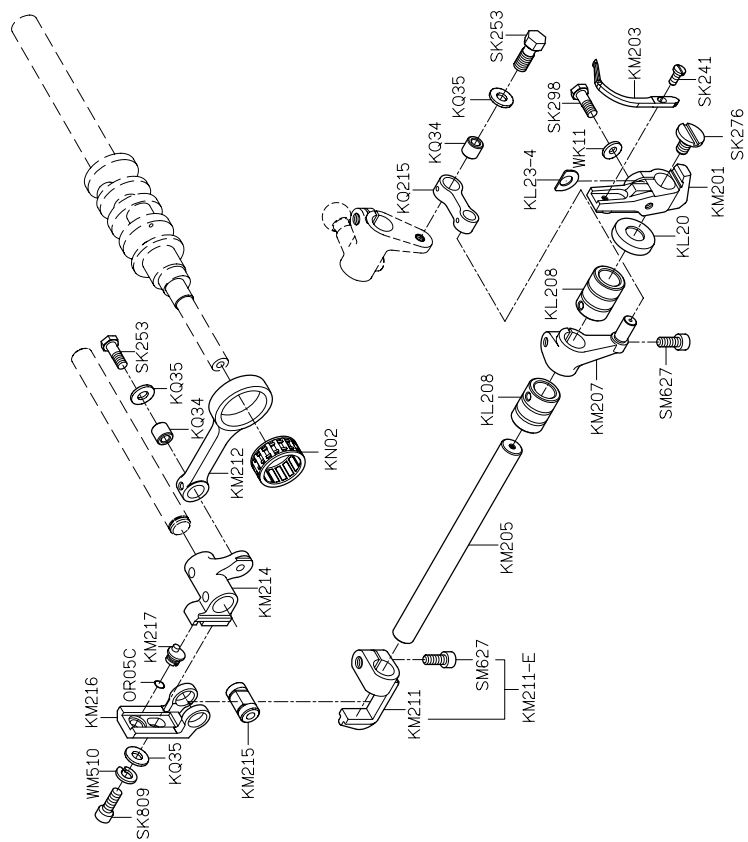
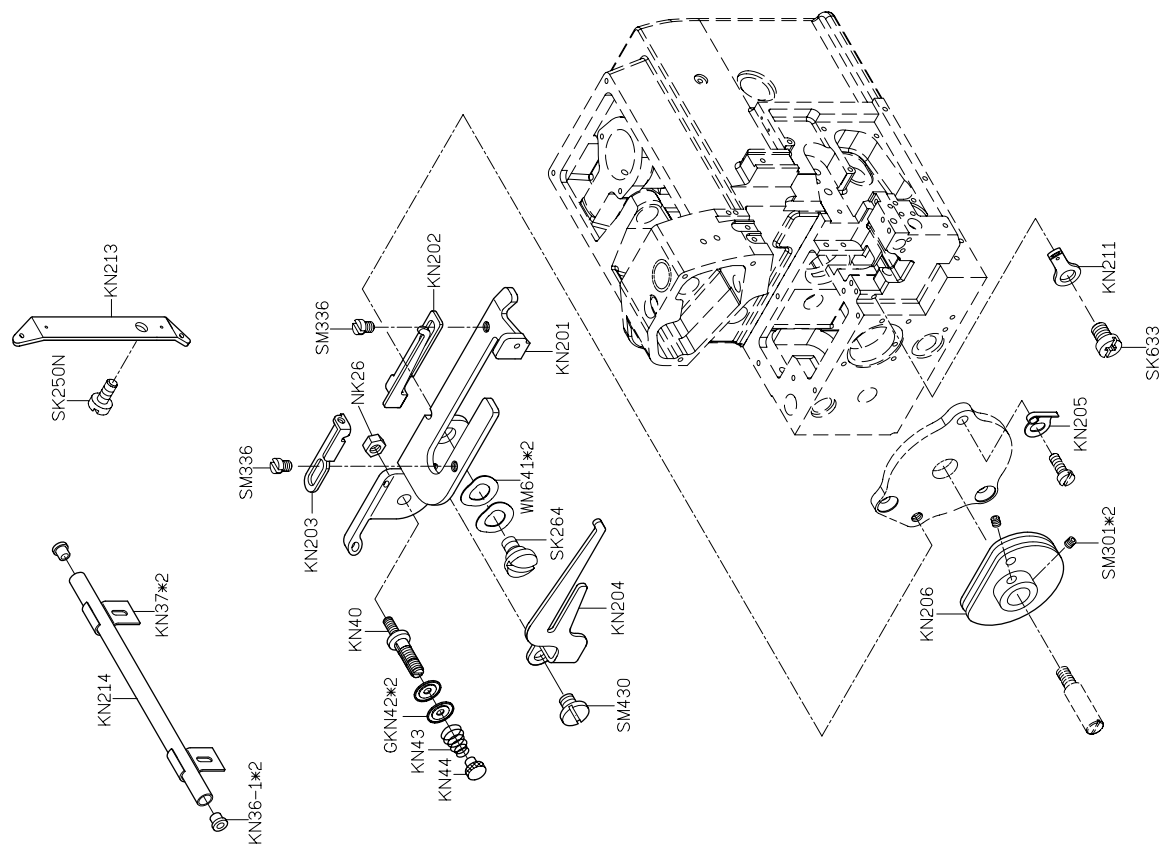

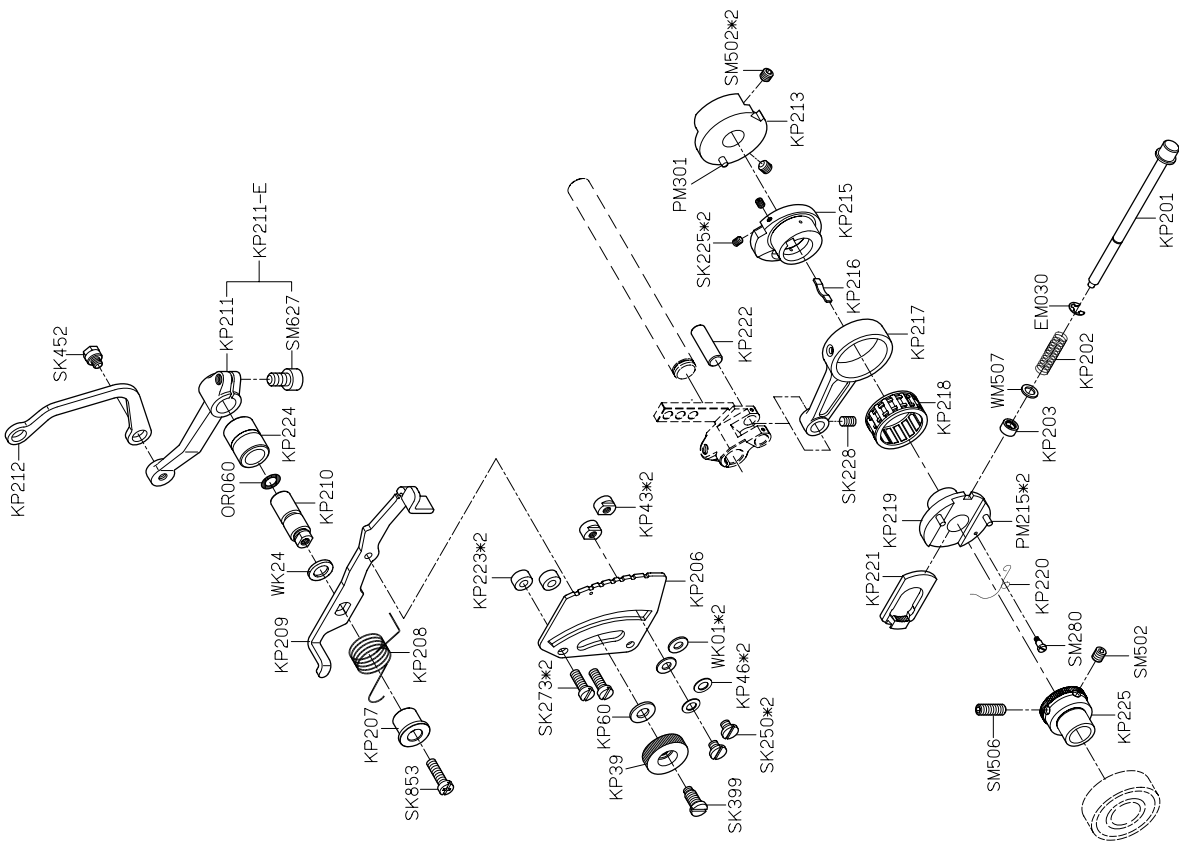

PARTS LIST FOR KP GROUP

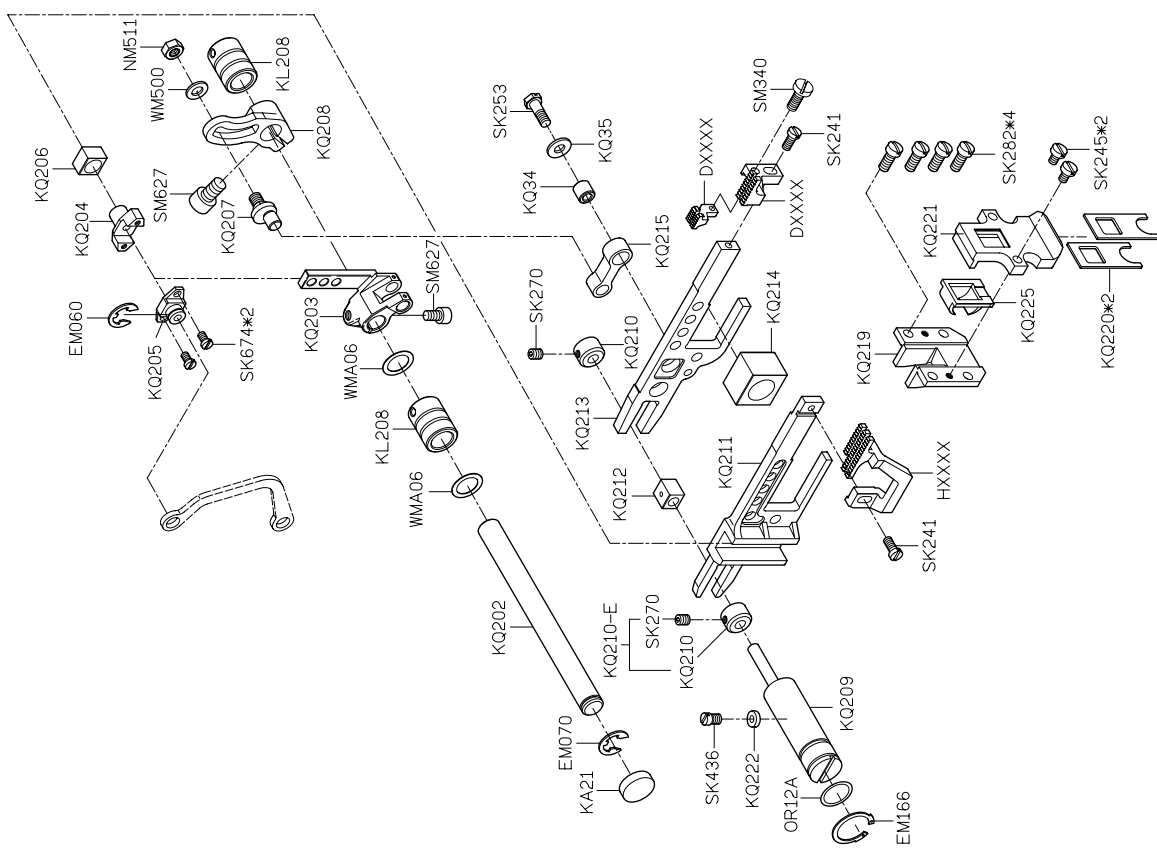

PARTS LIST FOR KQ GROUP

PARTS LIST FOR KR GROUP

| MODEL | 3線 / 4線 | 5線 / 6線 |
|----------|---------|---------|
| PARTS NO | KR202 | KR218 |
| | KR206 | KR221 |
| | KR209 | KR219 |

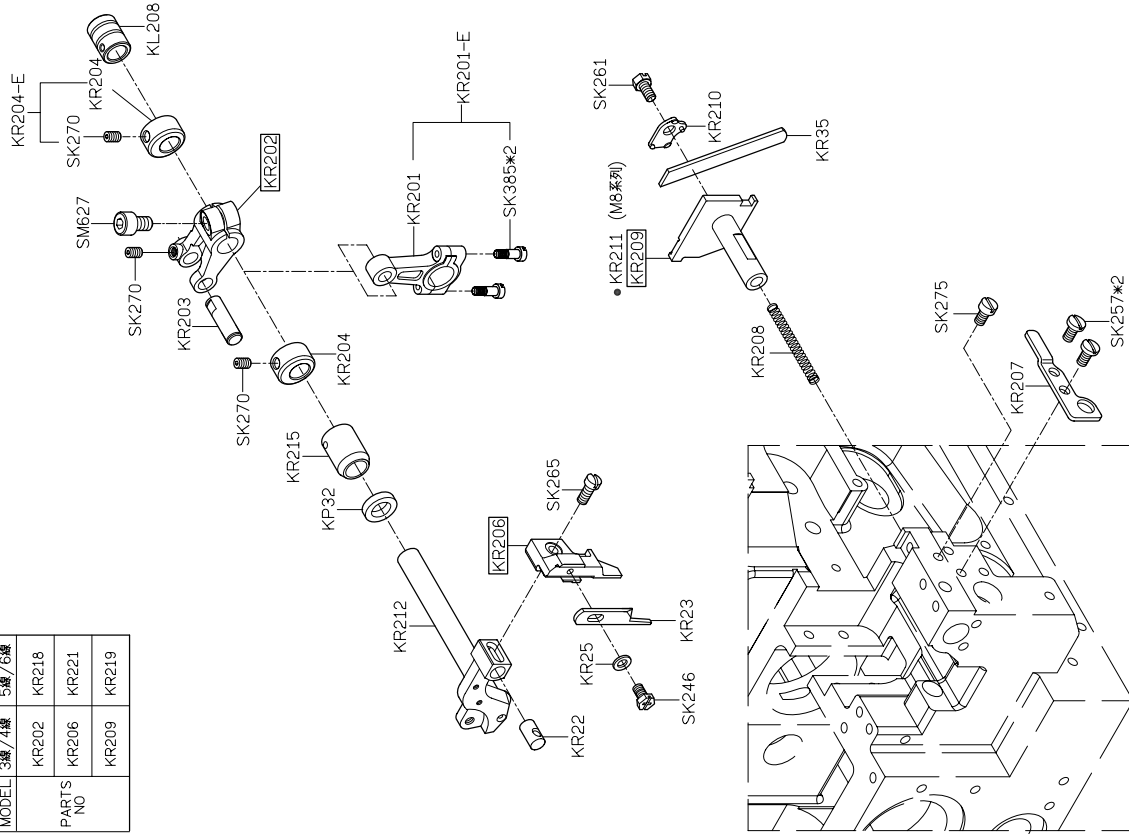

PARTS LIST FOR KS GROUP

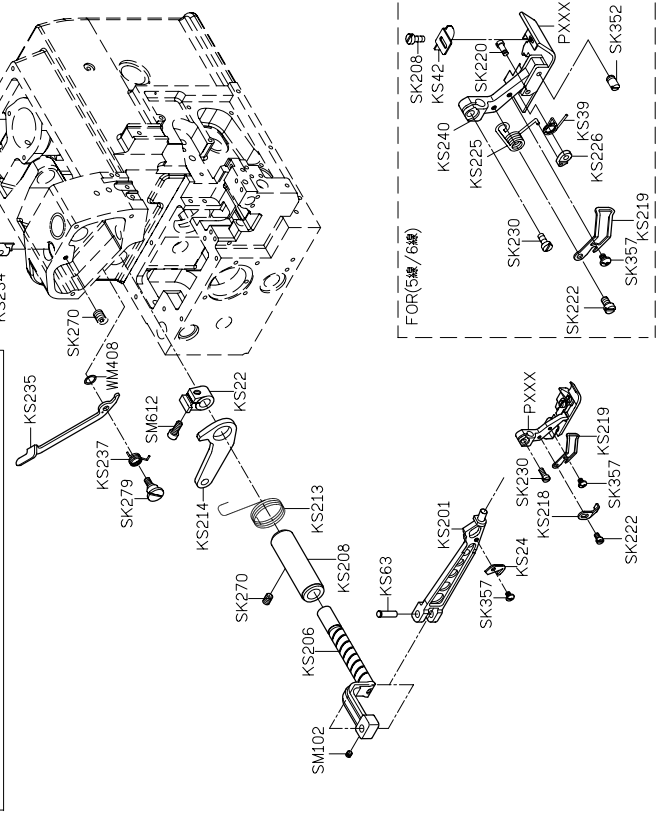
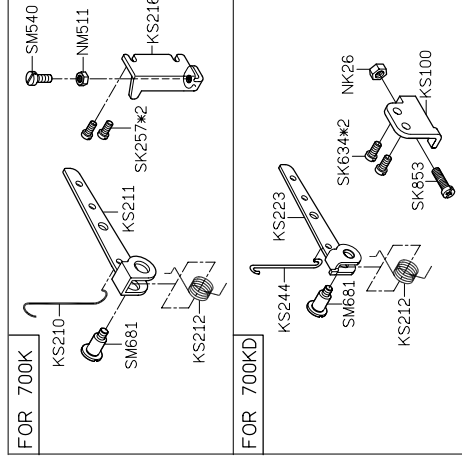

| MODEL | 3線/4線 | 5線/6線 |
|----------|----------------------------------|----------------------------------|
| PARTS NO | GKU40 KU207 KU206 SK277 | GKU39 KU209 KU211 SK437 |

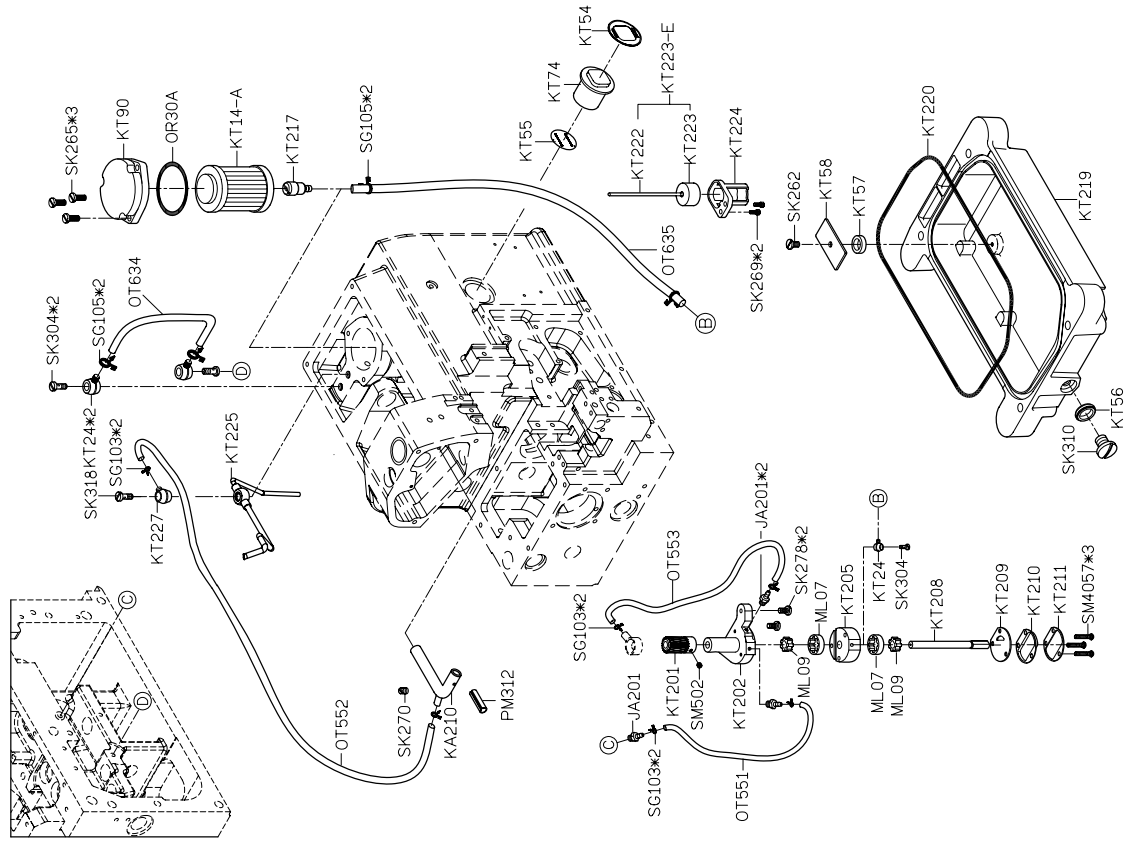

PARTS LIST FOR KT GROUP

PARTS LIST FOR KU GROUP

PARTS LIST FOR KW GROUP

KW40E-3

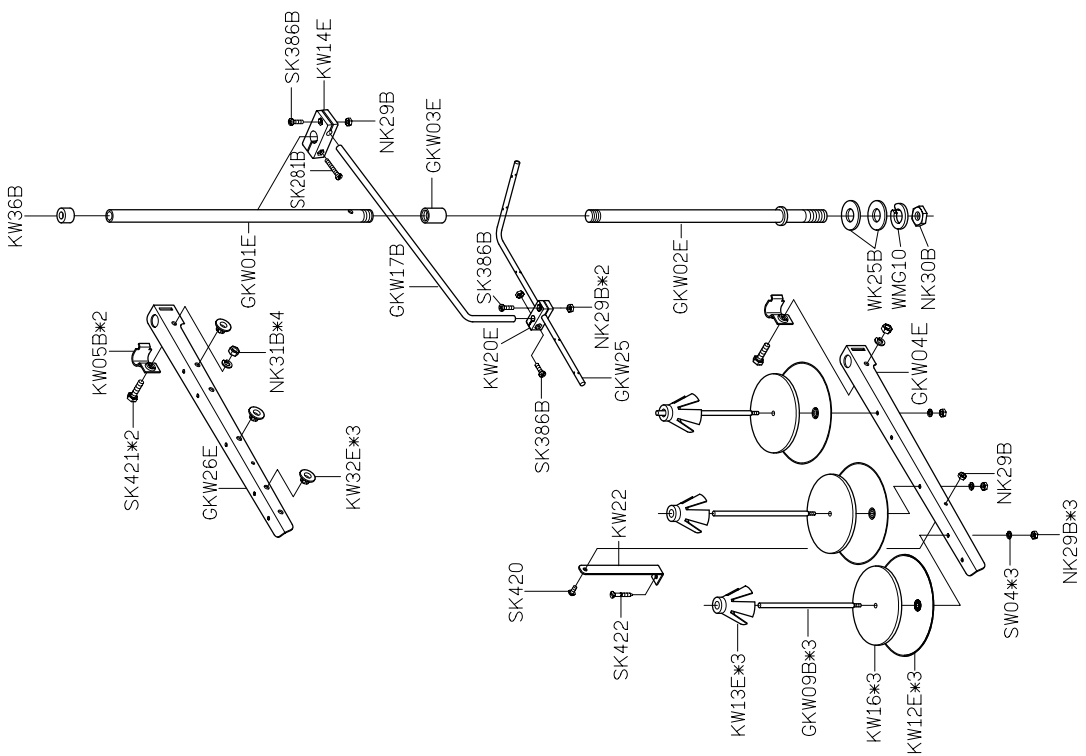

PARTS LIST FOR KW GROUP

KW40E-4

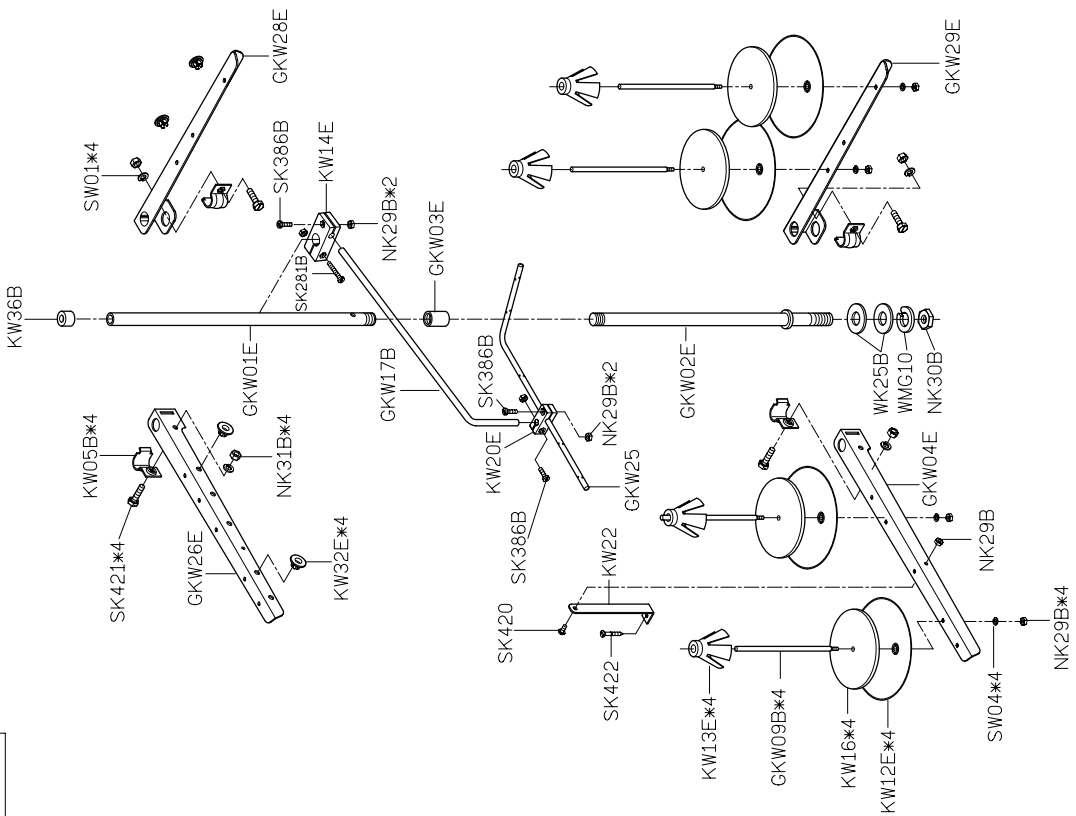

KW40E-5

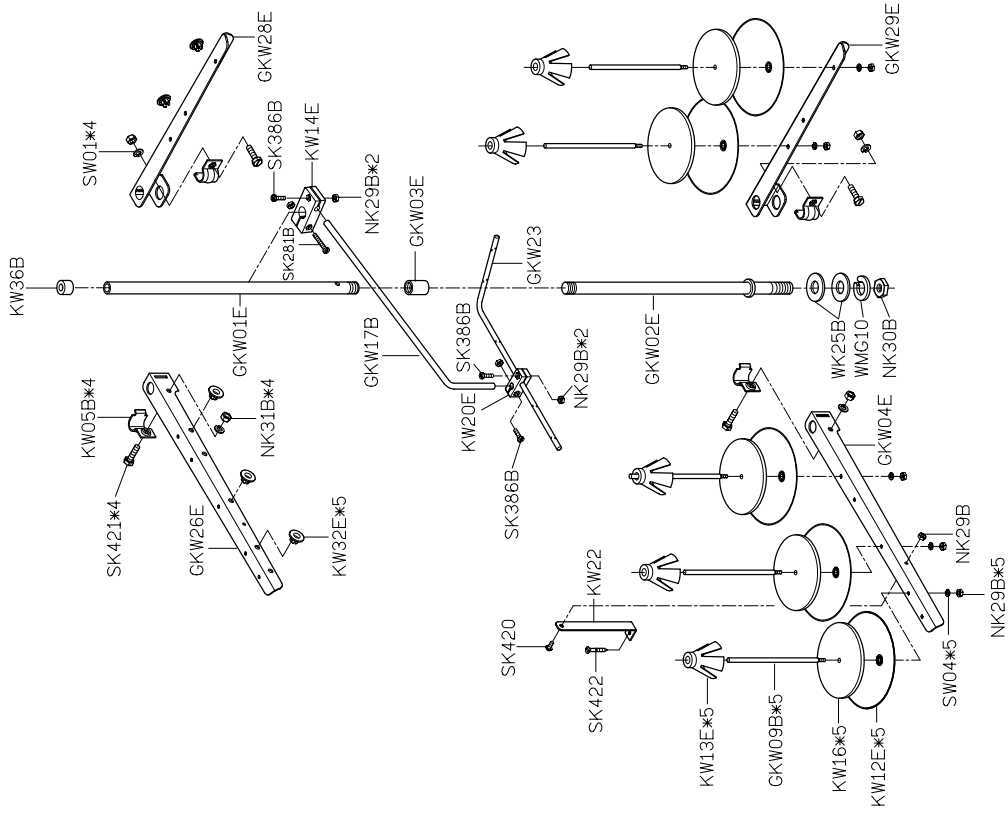

KW40E-6

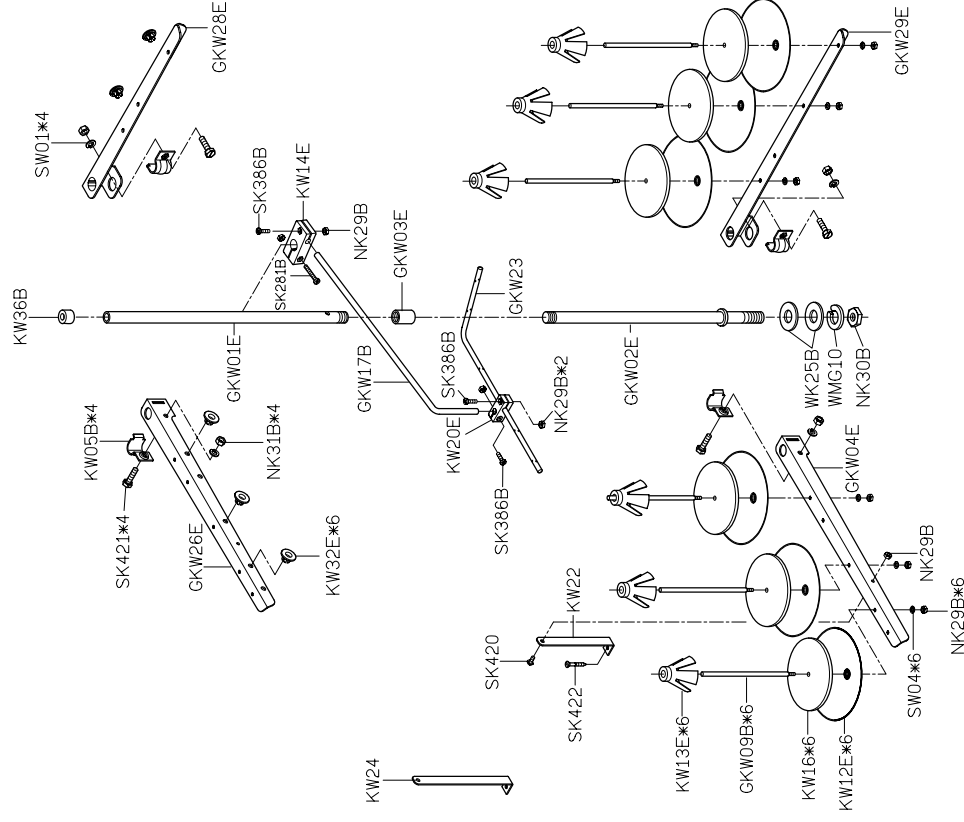

PARTS LIST FOR KX GROUP

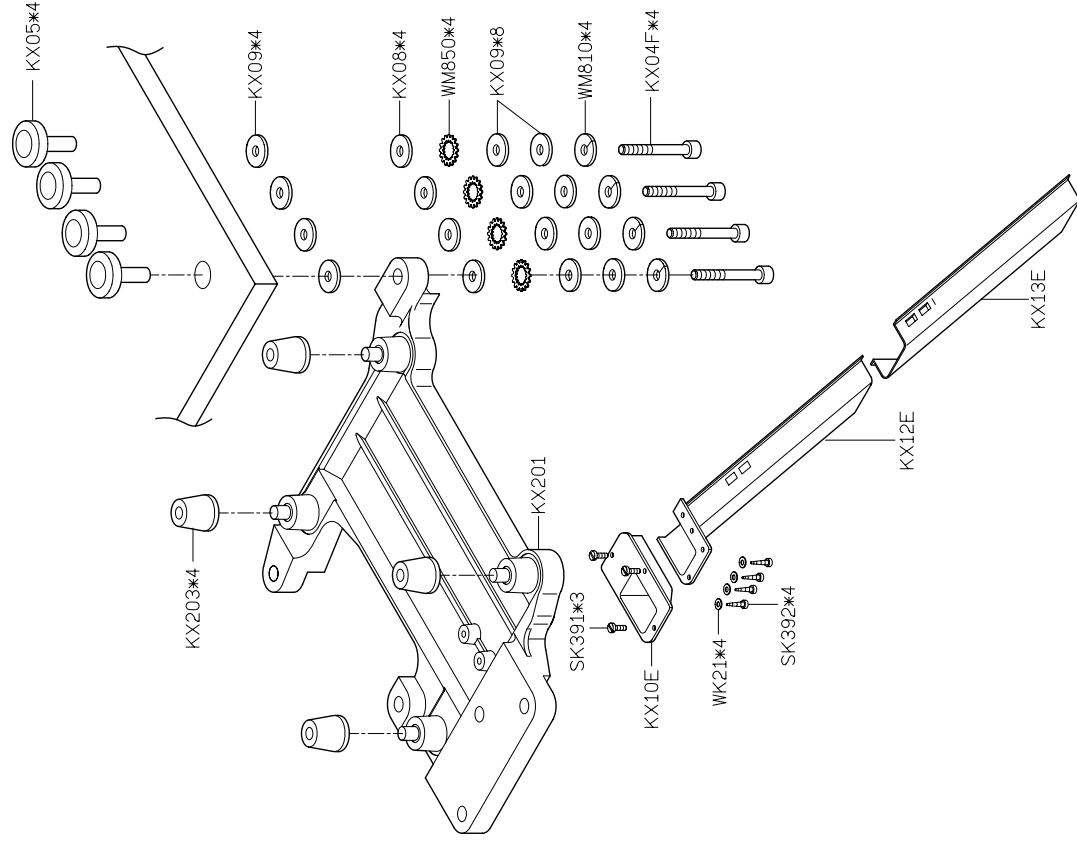

PARTS LIST FOR KY GROUP

| | | | | |
|--------------------|---------------------|--------------------------|-------------------|------------------|
| GKY01-1 防塵罩 | KY02F-A 油罐 | KY03 油壺 | KY04 漏斗 | KY05-A 油壺 |
| KY07 開口板手 | KY08 開口板手 | KY09 開口板手 | KY10 六角板手 | KY11 六角板手 |
| KY12 六角板手 | KY14 內六角螺絲起子 | KY16 一字起子 | KY17 一字起子 | KY18 鑷子 |
| KY19 穿線器 | GKY20D 腳踏板 | KY21-A/MY21 鉤子/鍊條 | GKY26F 工具袋 | |
| KR35 下刀片 | KT14-A 濾油器 | KY30 針板紙 | KZ03 乾燥濟 | 針*5 車針 |
| KZ08J 使用說明書 | KZ08J-2 零件圖 | SK216 螺絲 | | |

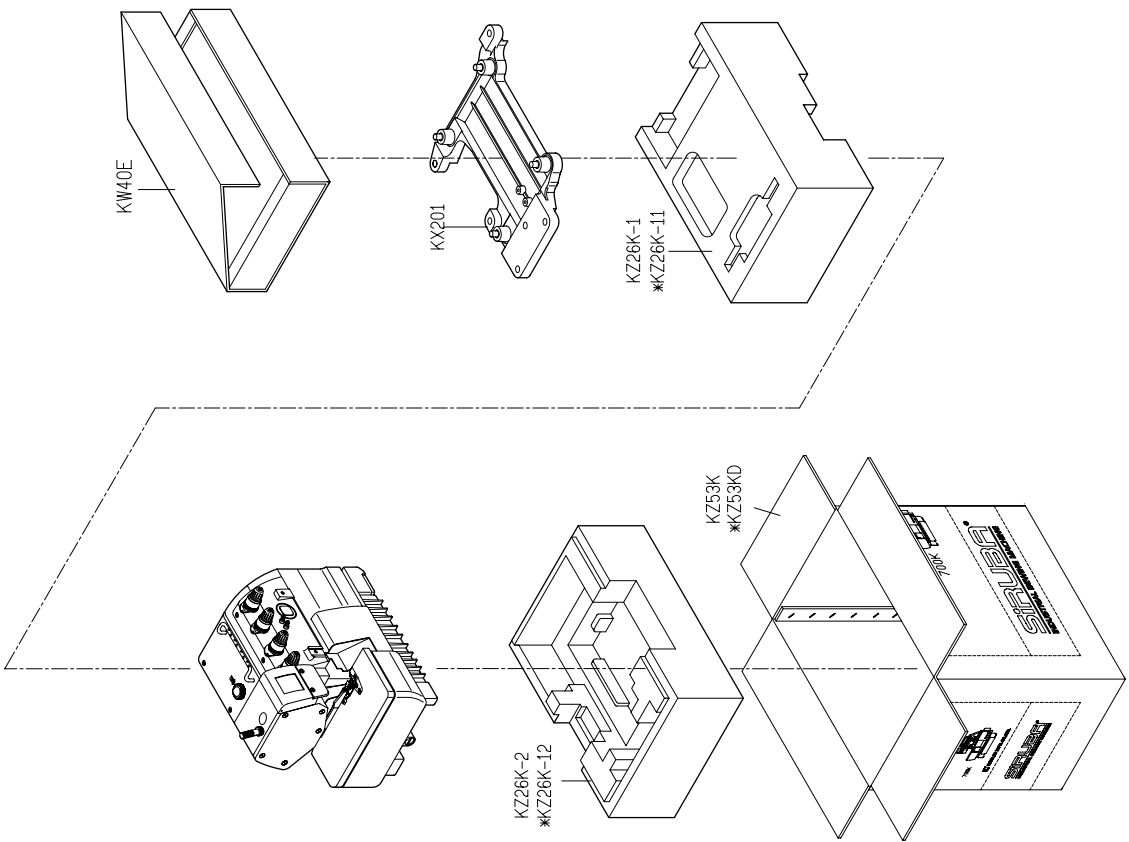



700K

高林股份有限公司 KAULIN MFG. CO., LTD.