

LH-3528/LH-3528-7/LH-3568/LH-3568-7/LH-3578/LH-3578-7/LH-358  
8/LH-3588-7

### FRAME & MISCELLANEOUS COVER COMPONENTS

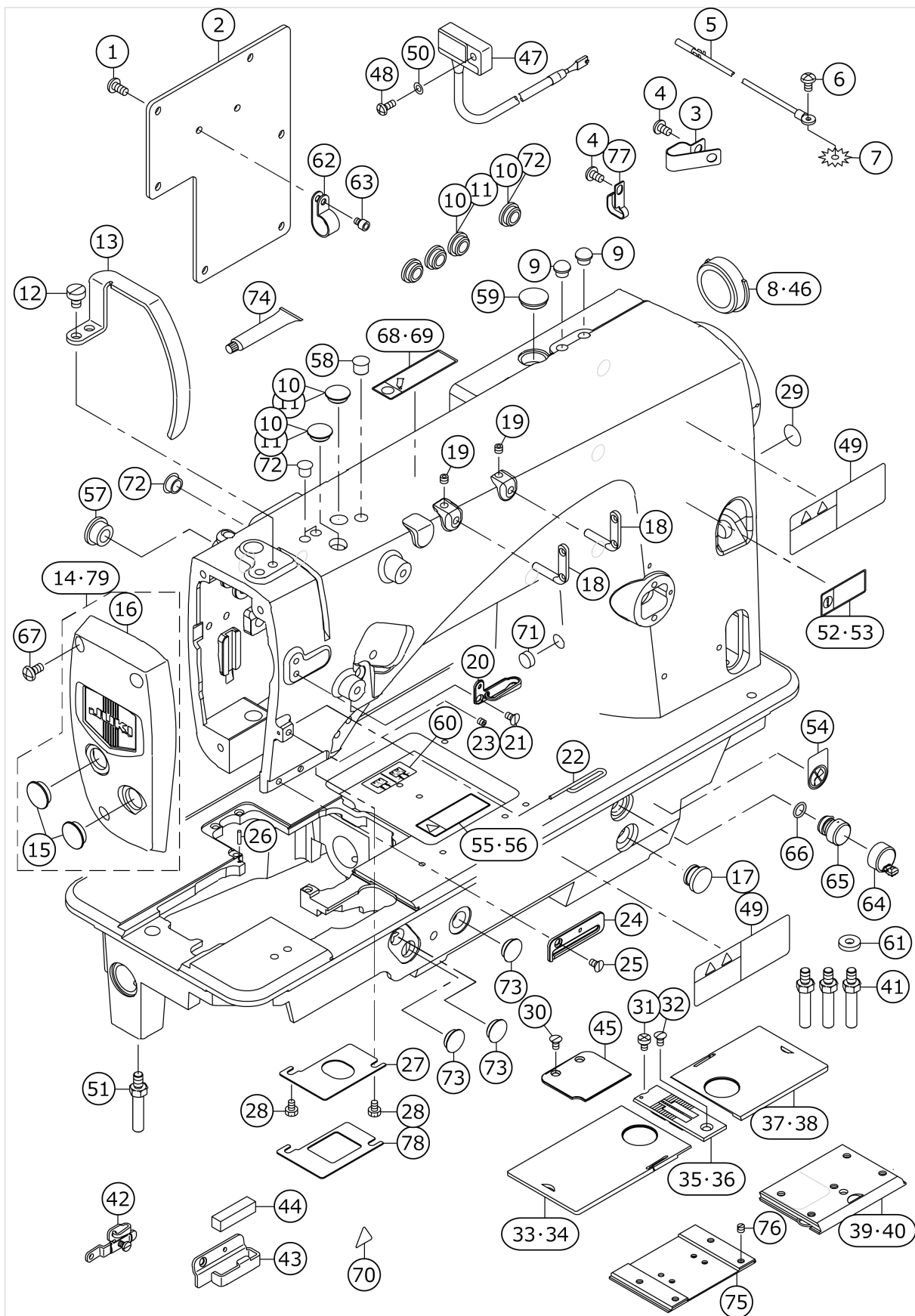

No.	品番	品名	備考	子部品	消耗品	個数
1	SM4051455SP	SCREW M5 L=14				6.00
2	40028766	REAR_PLATE				1.00
3	D2112555B00	CORD HOLDER, LARGE	FOR LH-3528-0B,LH-3528-7			3.00
4	SM4050855SP	SCREW	FOR LH-3528-0B,LH-3528-7			4.00
5	23601057	EARTH CORD ASM.	FOR LH-3528-0B,LH-3528-7			1.00
6	SM4050855SP	SCREW	FOR LH-3528-0B,LH-3528-7			1.00
7	WT0530002KS	TOOTHED WASHER D=5.3	FOR LH-3528-0B,LH-3528-7			1.00
8	22619100	CAP	FOR LH-3528			1.00
9	TA0800504R0	PLUG D=8 L=4.5	FOR LH-3528			2.00
10	TA1250406R0	RUBBER PLUG D=12.5 L=4	EXCEPT CHINA			6.00
11	TA1250406R0	RUBBER PLUG D=12.5 L=4	FOR CHINA			5.00
12	SM6060800SP	SCREW M6 L=8				2.00
13	40028245	THREAD_TAKE_UP_LEVER_COVER				1.00
14	40030298	ASSY_FACE_COVER_28				1.00
15	TA1600406R0	PLUG		*		2.00
16	40029641	FACE_COVER_28		*		1.00
17	TA1250705R0	RUBBER PLUG				1.00
18	22920706	TWO EYELET				2.00
19	SM8050412TP	SCREW M5 L=4				2.00
20	40029078	THREAD_GUIDE_UPPER				1.00
21	SM1040750TP	SCREW M4 L=7				1.00
22	40029347	THREAD_GUIDE_WIRE				1.00
23	SM8040402TP	SCREW M4X0.7 L=4				1.00
24	40028707	THREAD_GUIDE_LOWER	FOR LH-3528,LH-3528-7,LH-3568,LH-3568-7			1.00
25	SM1040750TP	SCREW M4 L=7				1.00
26	B1104051000	THROAT PLATE PIN				1.00
27	40028730	PLATE	FOR LH-3528,LH-3528-7,LH-3578,LH-3578-7			1.00
28	SM9040603SC	SCREW M4 L=6				2.00
29	22901805	GROUND MARK				1.00
30	SM1040750TP	SCREW M4 L=7	FOR LH-3528-7			2.00
31	SM6040655TP	SCREW M4 L=6				1.00
32	SM2040750TP	SCREW M4 L=7.4				1.00
33	22601058	BED SLIDE LEFT, ASM., A	EXCHANGING GAUGE PARTS FOR LH-3528(SEE.P.3 7,38)			1.00
34	40025247	ASSY_SLIDE_PLATE-L-A	EXCHANGING GAUGE PARTS FOR LH-3528-7(SEE.P.39)			1.00
35	22625503	THROAT PLATE 1/4	EXCHANGING GAUGE PARTS FOR LH-3528(SEE.P.3 7,38)			1.00

36	40025492	THROAT_PLATE_TRIM-1/4	EXCHANGING GAUGE PARTS FOR LH-3528-7(SEE.P.39)			1.00
37	22600555	BED SLIDE RIGHT, ASM., A	EXCHANGING GAUGE PARTS FOR LH-3528(SEE.P.37,38)			1.00
38	40025235	ASSY_SLIDE_PLATE-R-A	EXCHANGING GAUGE PARTS FOR LH-3528-7(SEE.P.39)			1.00
39	40042880	ASSY_SLIDE_PLATE_F	FOR LH-3528-7			1.00
40	40042874	ASSY_SLIDE_PLATE_F_STANDARD	FOR LH-3528			1.00
41	40028555	STUD				3.00
42	40034675	THREAD_GUIDE_ASM_E	OPTIONAL PARTS (TYPE G)(FOR LH-3578,LH-3578-7,LH-3588,LH-3588-7)			1.00
43	40032896	THREAD_GUIDE_FELT	TYPE A(Accessorie parts)			1.00
44	22603708	FELT	TYPE A(Accessorie parts)			1.00
45	40028706	AUXILIARY_COVER	FOR LH-3528-7			1.00
46	22657803	RUBBER PLUG	FOR LH-3528-7			1.00
47	40034053	RESISTANCE PACK AA ASM.	FOR LH-3528-0B,LH-3528-7			1.00
48	SM4041055SP	SCREW	FOR LH-3528-0B,LH-3528-7			1.00
49	CM301300001	SAFETY LABEL	FOR LH-3528-7			2.00
50	WP0430800SD	WASHER M4	FOR LH-3528-0B,LH-3528-7			1.00
51	40035180	BED_SCREW_STUD_B				1.00
52	CM200200201	LABEL_02_C	FOR CHINA			1.00
53	CM200200202	LABEL_02	EXCEPT CHINA			1.00
54	CM100100001	OIL INJECTION PROHIBITION LABEL				1.00
55	CM301100102	LABEL_03	EXCEPT CHINA			1.00
56	CM301100101	LABEL_03_C	FOR CHINA			1.00
57	TA1470704R0	RUBBER PLUG				1.00
58	TA0950806R0	RUBBER PLUG				1.00
59	TA1650406R0	PLUG				1.00
60	40026811	THREADING_DIAGRAM				1.00
61	40036690	WASHER				1.00
62	EA9502B0200	CABLE CLIP C				2.00
63	SM6040552TP	SCREW M4 L=4.5				2.00
64	23601305	AIR-DISCHARGING CAP				1.00
65	40063940	AIR_DISCHARGING				1.00
66	RO080150200	RUBBER RING				1.00
67	SM4051055SP	SCREW				3.00
68	CM200100102	LABEL_01	EXCEPT CHINA			1.00

69	CM200100101	LABEL_01_C	FOR CHINA			1.00
70	CM300200001	ATTENTION SEAL				1.00
71	TA1030402R0	RUBBER PLUG D=10.3 L=4				1.00
72	TA0750704R0	RUBBER PLUG				2.00
73	TA1250406R0	RUBBER PLUG D=12.5 L=4				3.00
74	40006323	JUKI GREASE A TUBE				1.00
75	23206709	BED SLIDE (FRONT)A	SELECTIVE PARTS			1.00
76	SS8110410TP	SCREW 11/64-40 L= 3.5	SELECTIVE PARTS			1.00
77	40022407	CORD HOLDER				1.00
78	40028731	PLATE	FOR LH-3568,LH -3568-7,LH-358 8,LH-3588-7			1.00
79	40030299	ASSY_FACE_COVER_68				1.00



# MAIN SHAFT & THREAD TAKE-UP COMPONENTS

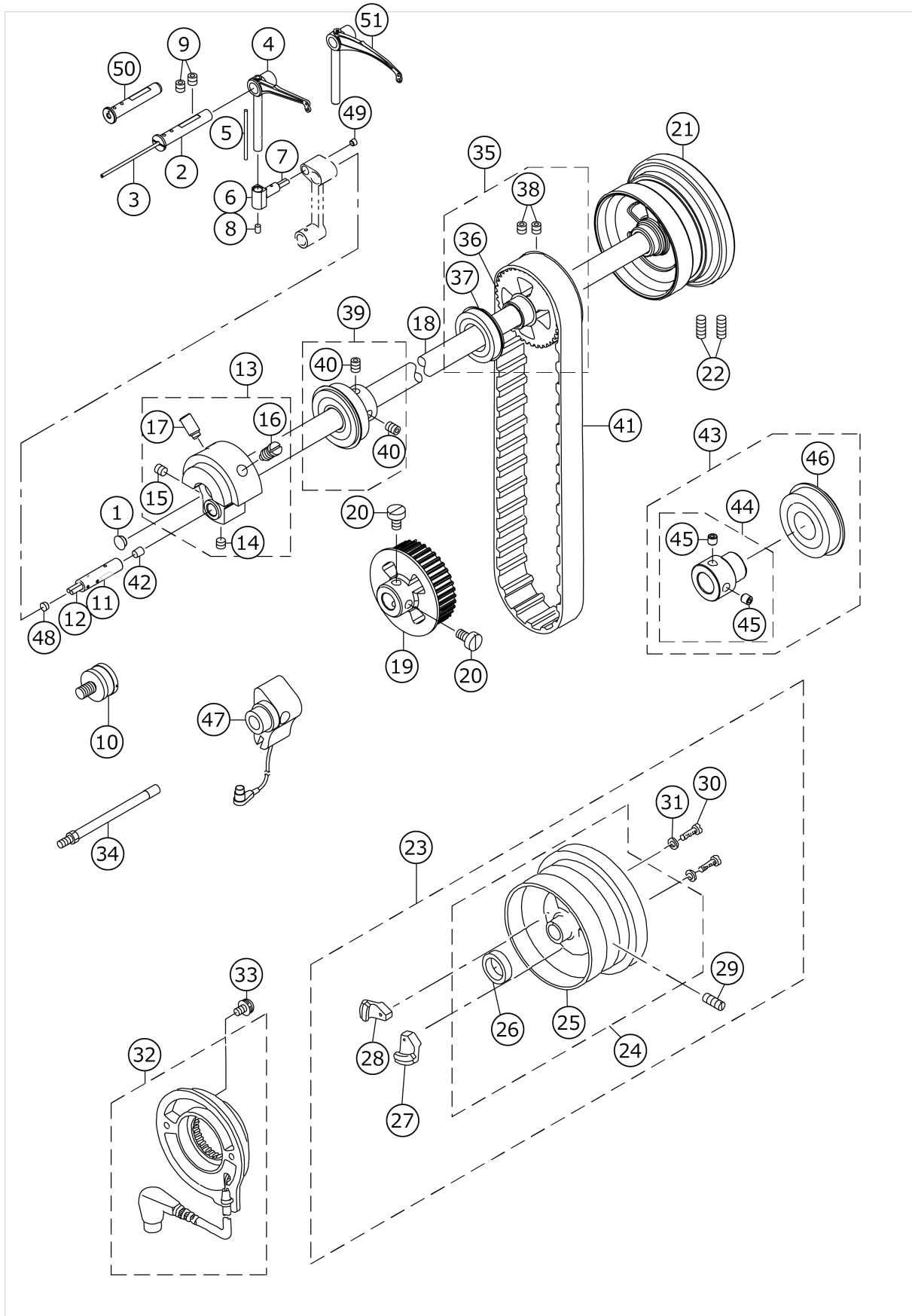

No.	品番	品名	備考	子部品	消耗品	個数
1	TA0750404R0	PLUG D=7.5 L=3.5				1.00
2	22605307	THREAD TAKE-UP LEVER PIN	FOR LH-3528,LH -3528-7,LH-356 8,LH-3568-7			1.00
3	CQ202000000	OIL WICK				0.15
4	40024093	THREAD TAKE UP LEVER C	FOR LH-3528,LH -3528-7,LH-356 8,LH-3568-7			1.00
5	CQ202000000	OIL WICK				0.04
6	40022678	TAKE_UP_LEVER_THRUST_PIN				1.00
7	CQ252000000	OIL WICK				0.02
8	22810907	RUBBER PLUG				1.00
9	SM8060612TP	SCREW M6 L=6				2.00
10	22622401	SYNCRO FRNGE	OPTIONAL PARTS (FOR LH-3568)			1.00
11	40029964	NEEDLE_BAR_CRANK_PIN				1.00
12	CQ303000000	OIL WICK				0.02
13	40031864	ASSY_COUNTER_WEIGHT				1.00
14	SM8060552TP	SCREW M6 L=5		*		1.00
15	SM8060612TP	SCREW M6 L=6		*		1.00
16	40004171	COUNTER_WEIGHT_SCREW		*		1.00
17	SM8081652TP	SCREW M8 L=16		*		1.00
18	40024436	MAINSHAFT				1.00
19	40028117	LOWER_SPROCKET				1.00
20	SM6061150TP	SCREW M6 L=11				2.00
21	40032987	HAND_WHEEL	FOR LH-3568			1.00
22	SM8061550TP	SCREW M6 L=15	FOR LH-3568			2.00
23	40032993	COMP_HAND_WHEEL_TRIM	FOR LH-3568-7			1.00
24	40032994	ASSY_HAND_WHEEL_TRIM		*		1.00
25	40027099	HAND_WHEEL		*		1.00
26	M4002110000	GENERATOR ROTOR		*		1.00
27	40017624	MAGNET FITTING BASE A ASM.		*		1.00
28	40017625	MAGNET FITTING BASE B ASM.		*		1.00
29	SM8061550TP	SCREW M6 L=15		*		2.00
30	SS6111210SP	SCREW 11/64-40 L=12		*		2.00
31	WP0450801SD	WASHER 4.5X10X0.8		*		2.00
32	22937965	DYNAMO STATOR				1.00
33	SL4051001MZ	SCREW M5 L=9.6				2.00
34	40032142	SENSOR_SUPPORT_SHAFT_ASM.	OPTIONAL PARTS (FOR LH-3568)			1.00
35	40029048	ASSY_MAINSHAFT_BEARING_2				1.00
36	40028116	MAIN_SHAFT_SPROCKET		*		1.00
37	SB120002500	BEARING		*		1.00
38	SM8060612TP	SCREW M6 L=6		*		2.00
39	40029047	ASSY_MAINSHAFT_BEARING				1.00
40	SM8060612TP	SCREW M6 L=6		*		2.00
41	40028652	TIMING_BELT				1.00
42	TA0490601R0	PLUG D=4.9X5.5 L=6				1.00
43	40029049	ASSY_MAINSHAFT_BEARING_3				1.00
44	40033667	BEARING_BUSH_C_ASM.		*		1.00

45	SM8060812TP	SCREW M6 L=8		*		2.00
46	SB120002000	BEARING		*		1.00
47	40026920	SYNCHRONIZER ASM.	OPTIONAL PARTS (FOR LH-3568)			1.00
48	TA0500301R0	PLUG 5X5.8 L=3				1.00
49	TA0370301R0	PLUG D-3.7X4.4 L=3				1.00
50	40046212	THREAD_TAKE_UP_LEVER_PIN	FOR LH-3578,LH -3578-7,LH-358 8,LH-3588-7			1.00
51	40043322	TAKE_UP_LEVER_E_COATING	FOR LH-3578,LH -3578-7,LH-358 8,LH-3588-7			1.00

# NEEDLE BAR COMPONENTS (1)(FOR LH-3528,3528-7,3578,3578-7)

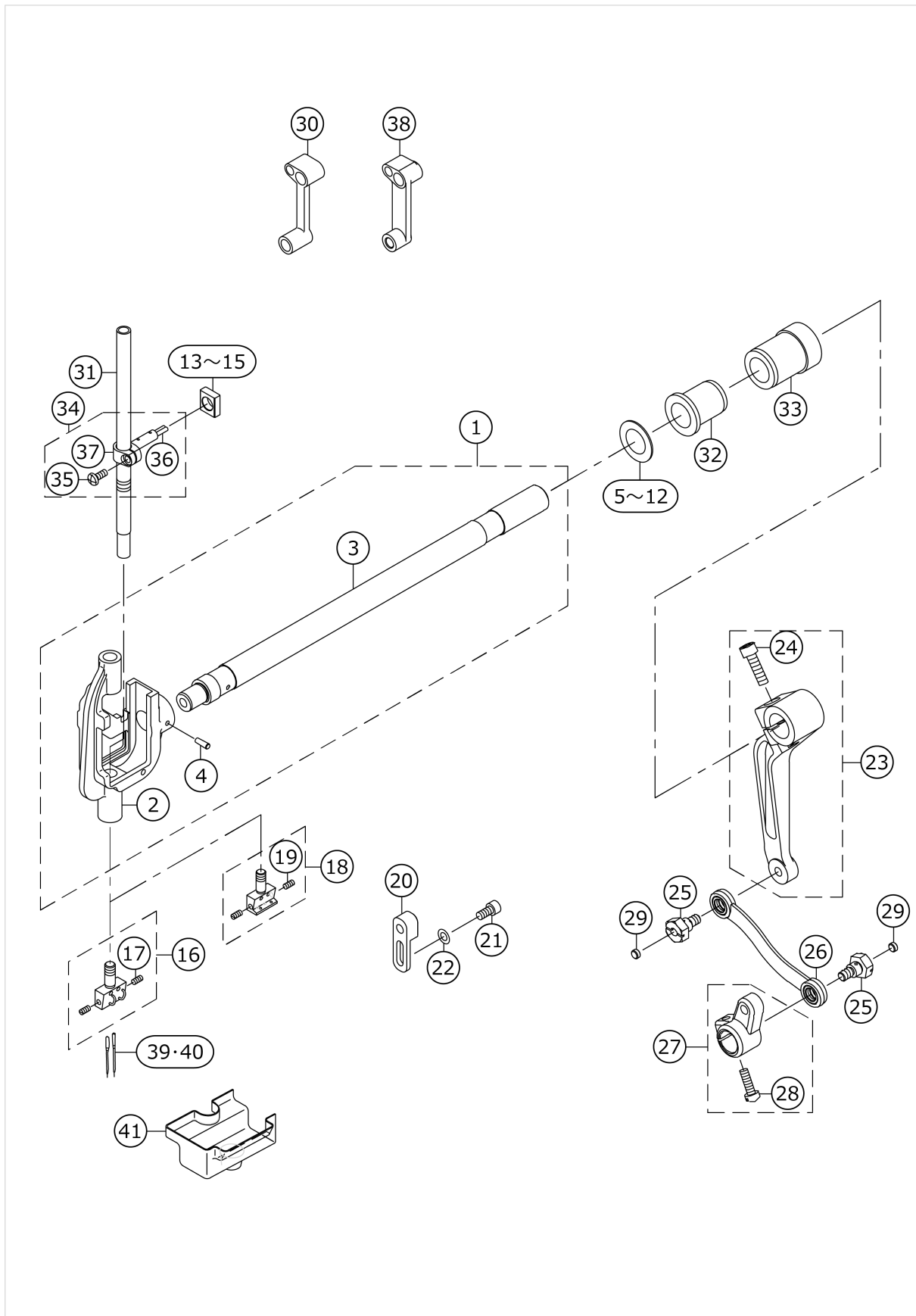

No.	品番	品名	備考	子部品	消耗品	個数
1	40026395	NEEDLE_BAR_ROCKING_BASE_ASM.				1.00
2	40026394	NEEDLE_BAR_ROCKING_BASE		*		1.00
3	40025329	NEEDLE_BAR_SHAFT		*		1.00
4	PT0502700S0	TAPERED PIN		*		1.00
5	22606206	SPACER Y	SELECTIVE PARTS			1.00
6	22606305	SPACER Z	SELECTIVE PARTS			1.00
7	22607600	SPACER A	SELECTIVE PARTS			1.00
8	22607709	SPACER B	SELECTIVE PARTS			1.00
9	B1438512B00	WASHER 17.1X28X1.5	SELECTIVE PARTS			1.00
10	22607808	SPACER D	SELECTIVE PARTS			1.00
11	22607907	SPACER E	SELECTIVE PARTS			1.00
12	22606404	SPACER F	SELECTIVE PARTS			1.00
13	23204506	ROCKING ROD SQUARE BLOCK A	SELECTIVE PARTS			1.00
14	23204605	ROCKING ROD SQUARE BLOCK B	SELECTIVE PARTS			1.00
15	23204704	ROCKING ROD SQUARE BLOCK C	SELECTIVE PARTS			1.00
16	40026035	ASSY_NEEDLE_CLAMP(1/4)	EXCHANGING GAUGE PARTS(SEE.P.38,39,42,43)			1.00
17	SS8080660TP	SCREW 1/8-44 L=5.5		*		2.00
18	10148054	NEEDLE CLAMP ASM. 1/4	TYPE G			1.00
19	SS8080660TP	SCREW 1/8-44 L=5.5		*		2.00
20	40028666	ROCKING_ROD_FIXING_BLOCK	FOR LH-3528			1.00
21	SM6051002TP	SCREW M5X0.8 L=10	FOR LH-3528			2.00
22	WP0550800SP	WASHER 5.5X10X0.8	FOR LH-3528			2.00
23	40033669	ASSY_REAR_ARM				1.00
24	SM6062502TP	SCREW M6 L=25		*		1.00
25	40026482	SHOULDER_SCREW				2.00
26	40032124	DRIVING_ROD_ASM.				1.00
27	40028853	ASSY_DRIVING_ARM				1.00
28	SM6051600SP	SCREW M5 L=16		*		1.00
29	13102702	THROAT PLATE COVER				2.00
30	40030037	NEEDLE_BAR_CRANK_ROD	FOR LH-3528,LH-3528-7			1.00
31	40028031	NEEDLE_BAR				1.00
32	40023568	BUSHING				1.00
33	40023569	BUSHING				1.00
34	40031862	ASSY_NEEDLE_BAR_CONNECTION				1.00
35	SM4041055SP	SCREW		*		1.00
36	CQ252000000	OIL WICK		*		0.04

37	40040302	NEEDLE_BAR_CONNECTION		*		1.00
38	40030038	NEEDLE_BAR_CRANK_ROD	FOR LH-3578,LH-3578-7			1.00
39	MDP500B1400	NEEDLE DPX5 #14	SELECTIVE PARTS			2.00
40	MDP500B2100	NEEDLE DPX5 #21	SELECTIVE PARTS			2.00
41	22606800	OIL GUARD RUBBER				1.00

# NEEDLE BAR COMPONENTS (2)(FOR LH-3568,3568-7,3588,3588-7)

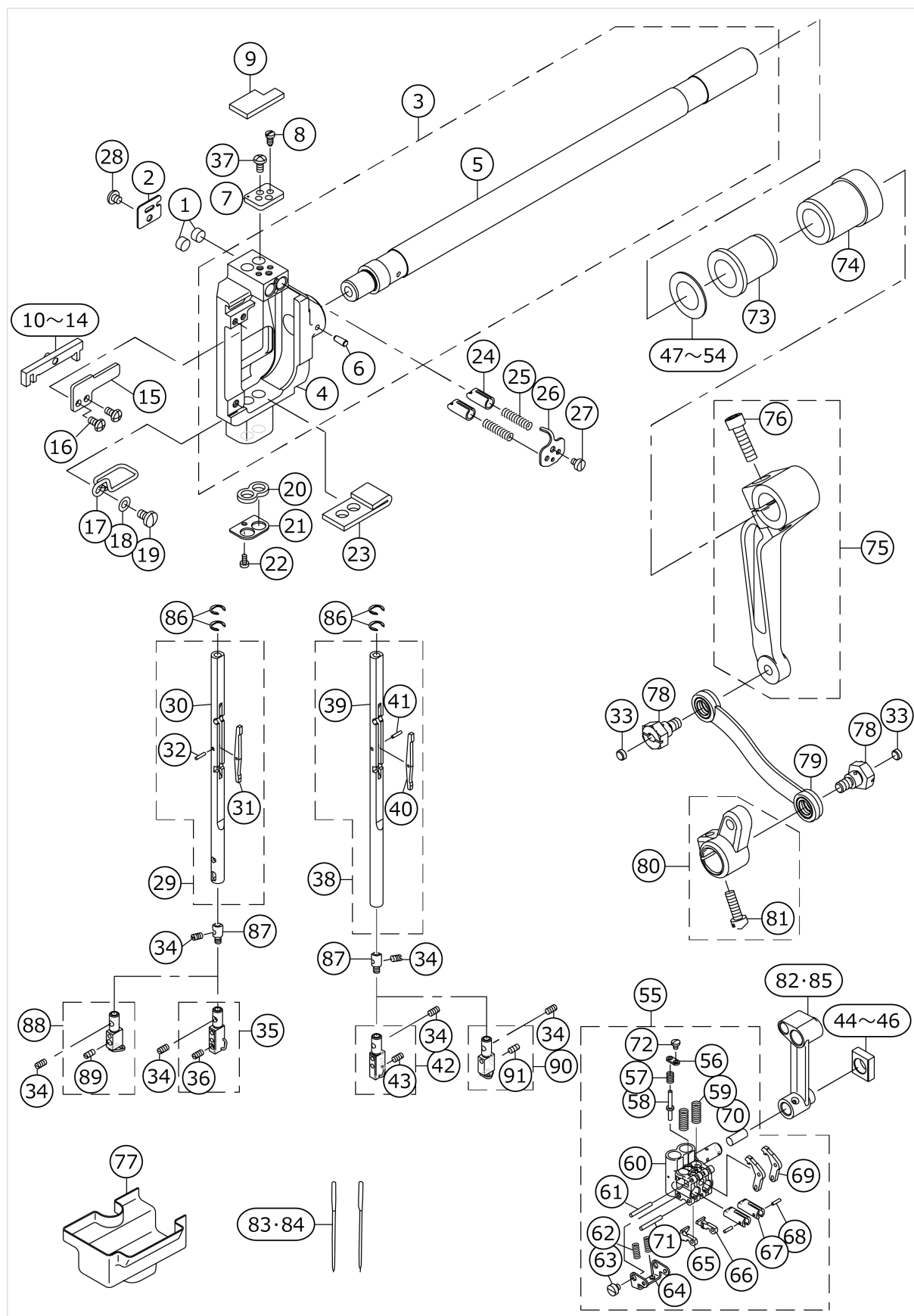

No.	品番	品名	備考	子部品	消耗品	個数
1	22903702	ROLLER FELT				2.00
2	22681209	FELT COVER				1.00
3	40026402	NEEDLE_BAR_ROCKING_BASE_ASM				1.00
4	40026401	NEEDLE_ROD_ROCKING_BASE		*		1.00
5	40025329	NEEDLE_BAR_SHAFT		*		1.00
6	PT0502700S0	TAPERED PIN		*		1.00
7	22682702	NEEDLE BAR SWIVEL STOPPER				1.00
8	22681712	STOPPER SCREW				2.00
9	40039629	FELT				1.00
10	22681951	SLIDER BLOCK ASM. A	SELECTIVE PARTS			1.00
11	22682058	SLIDER BLOCK ASM. B	SELECTIVE PARTS			1.00
12	22682157	SLIDE BLOCK	SELECTIVE PARTS			1.00
13	22682256	SLIDER BLOCK ASM. D	SELECTIVE PARTS			1.00
14	22682355	SLIDER BLOCK ASM. E	SELECTIVE PARTS			1.00
15	22681803	SLIDE BLOCK GUIDE PLATE				1.00
16	SS4090715SP	SCREW 9/64-40 L=7				2.00
17	22685903	FELT GUIDE				1.00
18	WP0450000SD	WASHER 4.5X8X0.5				1.00
19	SS7110710SP	SCREW 11/64-40 L=7				1.00
20	22686000	NEEDLE BAR OIL SEAL FELT, A				1.00
21	22685804	NEEDLE BAR OIL SEAL PLATE				1.00
22	SS6060510TP	SCREW 3/32-56 L=4.5				1.00
23	22686109	NEEDLE BAR OIL SEAL FELT, B				1.00
24	22681407	NEEDLE BAR STOPPER				2.00
25	22681506	SPRING				2.00
26	22681316	STOPPER SPRING COVER				1.00
27	SS6080410SP	SCREW 1/8-44 L=4				1.00
28	SS4090415SP	SCREW 9/64-40 L=4				1.00
29	40026983	NEEDLE_BAR_ASM_LEFT				1.00
30	40026982	NEEDLE_BAR_LEFT		*		1.00
31	22685200	SEESAW PLATE		*		1.00
32	22685408	NEEDLE BAR PIN		*		1.00
33	TA0370301R0	PLUG D-3.7X4.4 L=3				2.00
34	B1425526000	SCREW 1/8-44 L=6				4.00
35	40029561	ASSY_NEEDLE_CLAMP_L(1/4)	EXCHANGING GAUGE PARTS(SEE.P.40,41,44,45)			1.00
36	SS8080660TP	SCREW 1/8-44 L=5.5		*		2.00
37	SS4090715SP	SCREW 9/64-40 L=7				2.00
38	40026984	NEEDLE_BAR_ASM_RIGHT				1.00
39	40026981	NEEDLE_BAR_RIGHT		*		1.00
40	22685200	SEESAW PLATE		*		1.00
41	22685408	NEEDLE BAR PIN		*		1.00
42	40029562	ASSY_NEEDLE_CLAMP_R(1/4)	EXCHANGING GAUGE PARTS(SEE.P.40,41,44,45)			1.00



43	SS8080660TP	SCREW 1/8-44 L=5.5		*		2.00
44	23204506	ROCKING ROD SQUARE BLOCK A	SELECTIVE PARTS			1.00
45	23204605	ROCKING ROD SQUARE BLOCK B	SELECTIVE PARTS			1.00
46	23204704	ROCKING ROD SQUARE BLOCK C	SELECTIVE PARTS			1.00
47	22606206	SPACER Y	SELECTIVE PARTS			1.00
48	22606305	SPACER Z	SELECTIVE PARTS			1.00
49	22607600	SPACER A	SELECTIVE PARTS			1.00
50	22607709	SPACER B	SELECTIVE PARTS			1.00
51	B1438512B00	WASHER 17.1X28X1.5	SELECTIVE PARTS			1.00
52	22607808	SPACER D	SELECTIVE PARTS			1.00
53	22607907	SPACER E	SELECTIVE PARTS			1.00
54	22606404	SPACER F	SELECTIVE PARTS			1.00
55	40032147	NEEDLE_BAR_CONNECTION_ASM				1.00
56	40059036	RELEASE_PIN_COVER		*		1.00
57	22683304	SPRING		*		1.00
58	40024473	RELEASE_PIN		*		1.00
59	22683809	SPRING		*		2.00
60	40028679	NEEDLE_BAR_CONNECTION		*		1.00
61	22683403	NEEDLE BAR CONNECTION PIN		*		1.00
62	22684104	SPRING		*		2.00
63	SS6080340SP	SCREW 1/8-44 L=2.9		*		2.00
64	22684203	SPRING BRACKET		*		1.00
65	22683908	CLUTCH STOPPER, LEFT		*		1.00
66	22684005	CLUTCH STOPPER, RIGHT		*		1.00
67	40024064	NEEDLE_BAR_CLUTCH		*		2.00
68	B1705850000	STOPPER PIN		*		2.00
69	22683601	CLUTCH LEVER		*		2.00
70	CQ252000000	OIL WICK		*		0.03
71	40015144	NEEDLE BAR CONNECTION PIN		*		1.00
72	SS7060310SP	SCREW 3/32-56 L=3		*		1.00
73	40023568	BUSHING				1.00
74	40023569	BUSHING				1.00
75	40033669	ASSY_REAR_ARM				1.00
76	SM6062502TP	SCREW M6 L=25		*		1.00
77	22685705	OIL GUARD RUBBER				1.00
78	40026482	SHOULDER_SCREW				2.00
79	40032124	DRIVING_ROD_ASM				1.00
80	40028853	ASSY_DRIVING_ARM				1.00
81	SM6051600SP	SCREW M5 L=16		*		1.00
82	40028200	NEEDLE_BAR_CRANK_ROD	FOR LH-3568,LH-3568-7			1.00

83	MDP500B1400	NEEDLE DPX5 #14	SELECTIVE PARTS			2.00
84	MDP500B2100	NEEDLE DPX5 #21	SELECTIVE PARTS			2.00
85	40030027	NEEDLE_BAR_CRANK_ROD	FOR LH-3588,LH-3588-7			1.00
86	40028668	RING_A				4.00
87	22682504	SPRING BEARING				2.00
88	B1402528FALA	NEEDLE CLAMP ASM. 1/4	TYPE G			1.00
89	SS8080660TP	SCREW 1/8-44 L=5.5		*		2.00
90	B1402528FARA	NEEDLE CLAMP ASM. 1/4	TYPE G			1.00
91	SS8080660TP	SCREW 1/8-44 L=5.5		*		2.00

# TENSION POST COMPONENTS (1)(FOR LH-3528,3528-7,3578,3578-7)

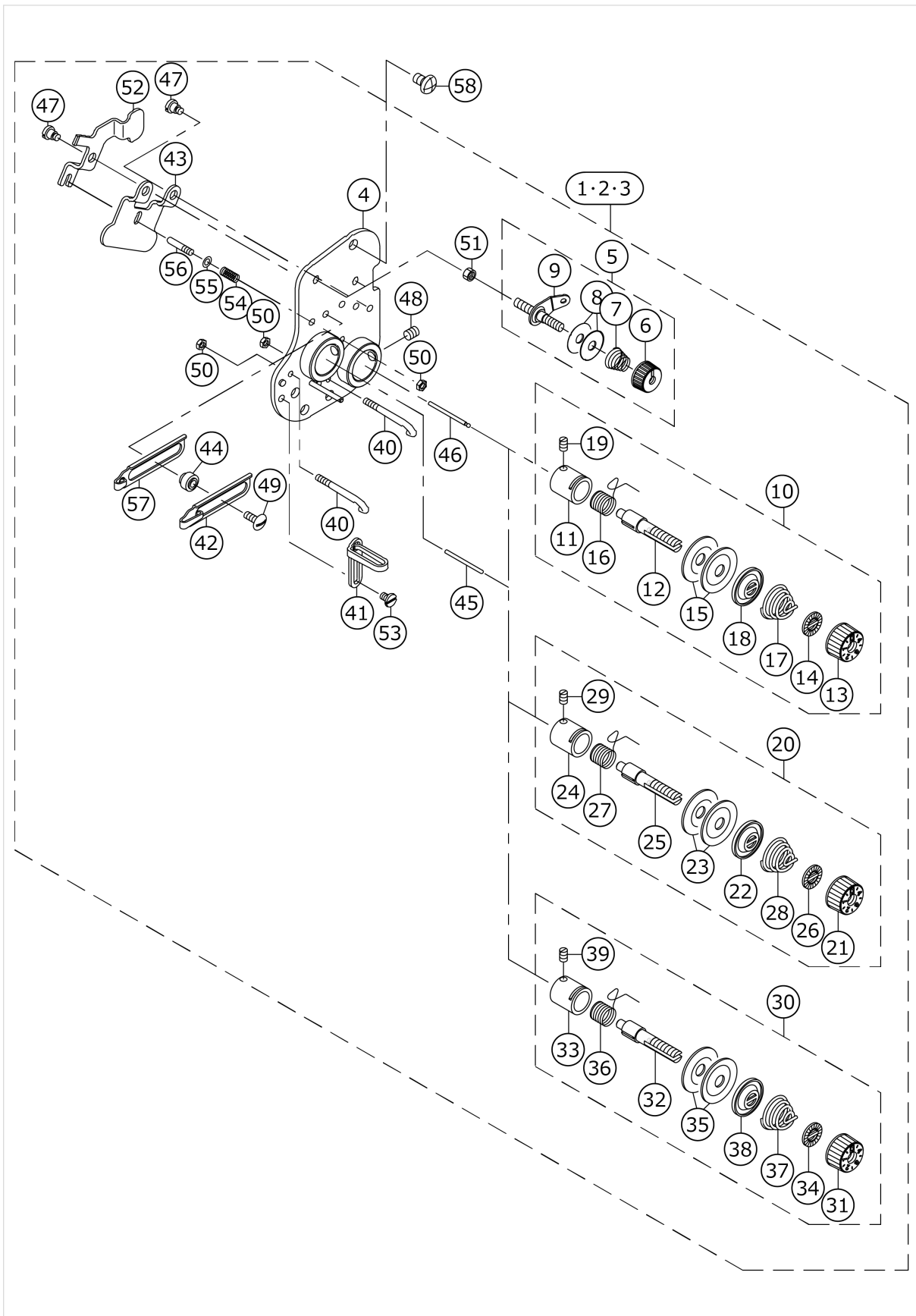

No.	品番	品名	備考	子部品	消耗品	個数
1	40032707	COMP_THREAD_TENSION_28S	TYPE S,F			1.00
2	40032708	COMP_THREAD_TENSION_28G	TYPE G			1.00
3	40032709	COMP_THREAD_TENSION_28A	TYPE A			1.00
4	40028250	ASSY_TENSION_BASE_PLATE		*		1.00
5	40052366	ASSY_THREAD_TENSION		*		2.00
6	11072402	THREAD TENSION NUT		*		1.00
7	22945505	THREAD TENSION SPRING		*		1.00
8	B3214047000	BOBBIN WINDER TENSION DISC		*		2.00
9	22529473	BOBBIN THREAD TENSION ROD ASM.		*		1.00
10	40056698	THREAD TENSION ASM.	TYPE S,F	*		1.00
11	22945307	THREAD TENSION POST BASE		*		1.00
12	22921209	THREAD TENSION POST		*		1.00
13	23626005	THREAD TENSION NUT		*		1.00
14	22921407	ROTATION STOPPER		*		1.00
15	22921506	THREAD TENSION DISK		*		2.00
16	22921605	THREAD TAKE-UP SPRING		*		1.00
17	B3129012A00	TENSION SPRING		*		1.00
18	22921803	DISK STOPPER		*		1.00
19	SS8090670SP	SCREW 9/64-40 L= 5.5		*		1.00
20	40025161	ASSY_THREAD_TENSION_G	TYPE G	*		1.00
21	23626005	THREAD TENSION NUT		*		1.00
22	22921803	DISK STOPPER		*		1.00
23	22921506	THREAD TENSION DISK		*		2.00
24	22945307	THREAD TENSION POST BASE		*		1.00
25	40025162	THREAD_TENSION_POST		*		1.00
26	22921407	ROTATION STOPPER		*		1.00
27	22921605	THREAD TAKE-UP SPRING		*		1.00
28	22962005	THREAD TENSION SPRING		*		1.00
29	SS8090670SP	SCREW 9/64-40 L= 5.5		*		1.00
30	23627458	THREAD TENSION ASM. ,F	TYPE A	*		1.00
31	23626005	THREAD TENSION NUT		*		1.00
32	B3115552000	TENSION POST		*		1.00
33	B3111126000	TENSION POST SOCKET		*		1.00
34	B3120125000	ROTATING STOPPER		*		1.00
35	B3126012000	THREAD TENSION DISK		*		2.00
36	D3128555D00	TAKE-UP SPRING		*		1.00
37	D3129555D00	THREAD TENSION SPRING		*		1.00
38	B3132552000	THREAD TENSION DISK PRESSER		*		1.00
39	SS8090670SP	SCREW 9/64-40 L= 5.5		*		1.00
40	B1118512000A	THREAD GUIDE A		*		2.00
41	40060693	THREAD_GUIDE_UPPER_A		*		1.00
42	40060840	THREAD_TAKE_UP_GUIDE_B		*		1.00
43	40034660	DISK_RELEASE_PLATE		*		1.00
44	23203300	THREAD GUIDE COLLAR		*		2.00
45	B3118552F00	TENSION RELEASING PIN		*		1.00
46	B3118552I00	TENSION RELEASING PIN I		*		1.00
47	SD0470316TP	SHOULDER SCREW D=4.7 H=3.1		*		3.00
48	SM8050612TP	SCREW M5X6		*		2.00
49	SS5091020SP	SCREW 9/64-40 L= 9.5		*		2.00
50	NS6080210SP	NUT 1/8-44		*		3.00

51	NS6110310SP	NUT 11/64-40		*		2.00
52	40034840	RELEASE_LEVER		*		1.00
53	SS6090520SP	SCREW 9/64-40 L= 5.0		*		1.00
54	40009222	PRESSER PLATE ADJUSTING SPRING		*		1.00
55	WP0350516SD	WASHER 3.5X6X0.5		*		1.00
56	40015699	SPRING_GUIDE		*		1.00
57	40060689	THREAD_TAKE_UP_GUIDE		*		1.00
58	SM4050855SP	SCREW				2.00

# TENSION POST COMPONENTS (2)(FOR LH-3568,3568-7,3588,3588-7)

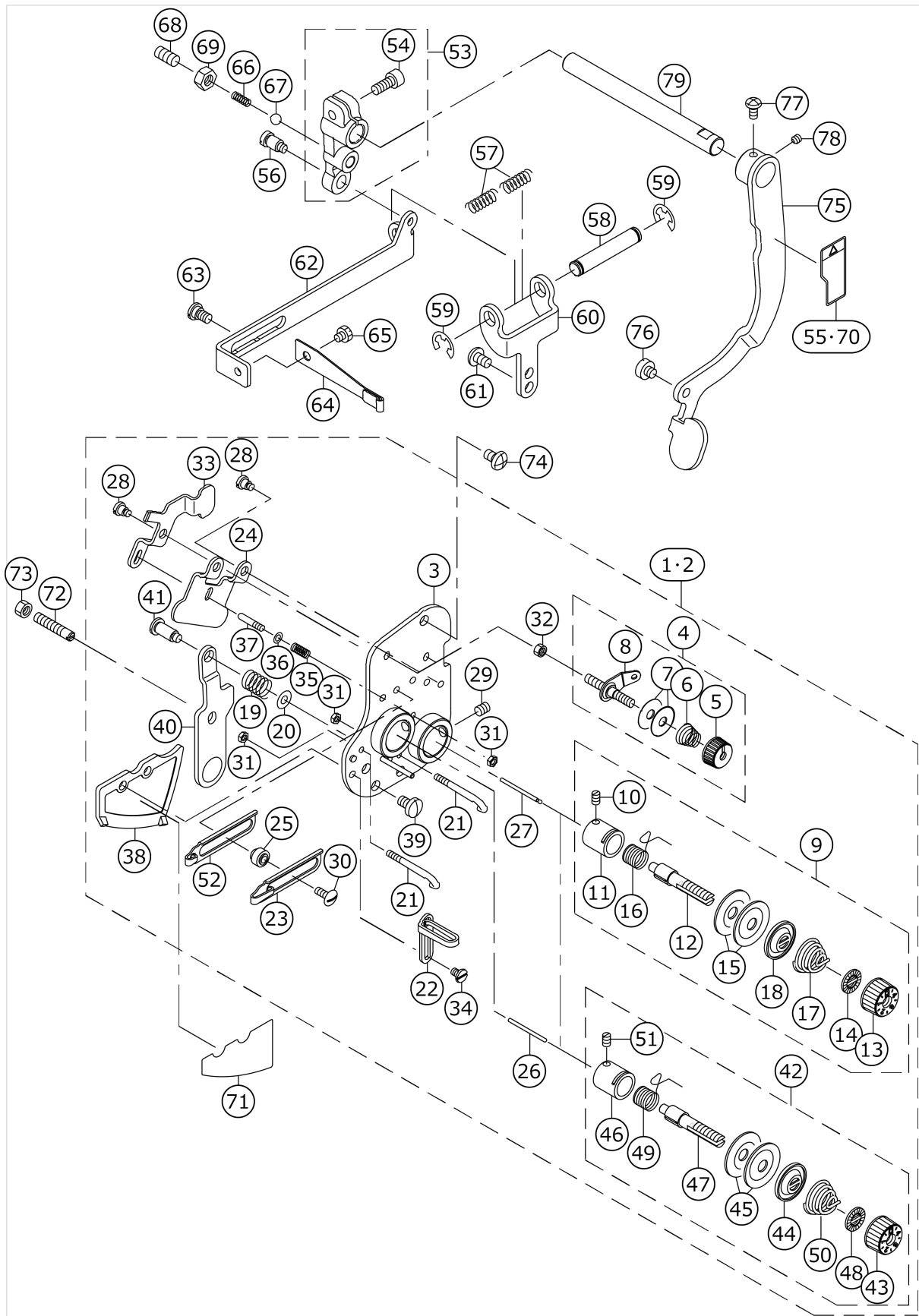

No.	品番	品名	備考	子部品	消耗品	個数
1	40032710	COMP_THREAD_TENSION_68S	TYPE S			1.00
2	40032711	COMP_THREAD_TENSION_68G	TYPE G			1.00
3	40028250	ASSY_TENSION_BASE_PLATE		*		1.00
4	40052366	ASSY_THREAD_TENSION		*		2.00
5	11072402	THREAD TENSION NUT		*		1.00
6	22945505	THREAD TENSION SPRING		*		1.00
7	B3214047000	BOBBIN WINDER TENSION DISC		*		2.00
8	22529473	BOBBIN THREAD TENSION ROD ASM.		*		1.00
9	40056698	THREAD TENSION ASM.	TYPE S	*		2.00
10	SS8090670SP	SCREW 9/64-40 L= 5.5		*		1.00
11	22945307	THREAD TENSION POST BASE		*		1.00
12	22921209	THREAD TENSION POST		*		1.00
13	23626005	THREAD TENSION NUT		*		1.00
14	22921407	ROTATION STOPPER		*		1.00
15	22921506	THREAD TENSION DISK		*		2.00
16	22921605	THREAD TAKE-UP SPRING		*		1.00
17	B3129012A00	TENSION SPRING	TYPE S	*		1.00
18	22921803	DISK STOPPER		*		1.00
19	B1449526000	REPOSITIONING LEVER SPRING		*		1.00
20	WP0450801SP	WASHER		*		1.00
21	B1118512000A	THREAD GUIDE A		*		2.00
22	40060693	THREAD_GUIDE_UPPER_A		*		1.00
23	40060840	THREAD_TAKE_UP_GUIDE_B		*		1.00
24	40034660	DISK_RELEASE_PLATE		*		1.00
25	23203300	THREAD GUIDE COLLAR		*		2.00
26	B3118552F00	TENSION RELEASING PIN		*		1.00
27	B3118552I00	TENSION RELEASING PIN I		*		1.00
28	SD0470316TP	SHOULDER SCREW D=4.7 H=3.1		*		3.00
29	SM8050612TP	SCREW M5X6		*		2.00
30	SS5091020SP	SCREW 9/64-40 L= 9.5		*		2.00
31	NS6080210SP	NUT 1/8-44		*		3.00
32	NS6110310SP	NUT 11/64-40		*		2.00
33	40034840	RELEASE_LEVER		*		1.00
34	SS6090520SP	SCREW 9/64-40 L= 5.0		*		1.00
35	40009222	PRESSER PLATE ADJUSTING SPRING		*		1.00
36	WP0350516SD	WASHER 3.5X6X0.5		*		1.00
37	40015699	SPRING_GUIDE		*		1.00
38	40028258	REPOSITIONING_LEVER_BASE		*		1.00
39	SM7050850TP	SCREW M5 L=8		*		2.00
40	40028262	REPOSITIONING_RELEASE_LEVER		*		1.00
41	SD0601171SP	HINGE SCREW D= 6 H=11.7		*		1.00
42	40025161	ASSY_THREAD_TENSION_G	TYPE G	*		1.00
43	23626005	THREAD TENSION NUT		*		1.00
44	22921803	DISK STOPPER		*		1.00
45	22921506	THREAD TENSION DISK		*		2.00
46	22945307	THREAD TENSION POST BASE		*		1.00
47	40025162	THREAD_TENSION_POST		*		1.00
48	22921407	ROTATION STOPPER		*		1.00
49	22921605	THREAD TAKE-UP SPRING		*		1.00
50	22962005	THREAD TENSION SPRING		*		1.00

51	SS8090670SP	SCREW 9/64-40 L= 5.5		*		1.00
52	40060689	THREAD_TAKE_UP_GUIDE		*		1.00
53	40032327	ASSY_REPOSITIONING_ARM				1.00
54	SM6051202TP	SCREW M5X0.8 L=12		*		1.00
55	CM300400902	LABEL_04	EXCEPT CHINA			1.00
56	SD0640752TP	HINGE SCREW D= 6.35 H= 7.5				1.00
57	22687503	SPRING				2.00
58	22687701	SPRING SHAFT				1.00
59	RE0700000K0	E-RING 7				2.00
60	22687602	SPRING BASE				1.00
61	SM4050855SP	SCREW				2.00
62	22687107	REPOSITIONING PLATE				1.00
63	SD0640247TP	SHOULDER SCREW D=6.35 H=2.4				2.00
64	22687008	LEAF SPRING				1.00
65	SS9110460CP	SCREW 11/64-40 L=4				1.00
66	40028641	ADJUSTING_SPRING				1.00
67	22615702	OIL ADJUSTING BALL				1.00
68	SM8061212TP	SCREW M6X12				1.00
69	NM6060001CP	NUT M6				1.00
70	CM300400901	LABEL_04_C	FOR CHINA			1.00
71	40035441	LABEL				1.00
72	40028843	LEVER_PIN_SCREW				1.00
73	NM6050001SP	NUT M5				1.00
74	SM4050855SP	SCREW				2.00
75	40028259	ASSY_REPOSITIONING_LEVER				1.00
76	SM6050450TP	SCREW M5 L=4				1.00
77	SM4040855SP	SCREW				1.00
78	SM8040412TP	SET SCREW M4 L=4				1.00
79	40028844	REPOSITIONING_LEVER_SHAFT				1.00



# HOOK & HOOK DRIVING SHAFT COMPONENTS (1)(FOR LH-3528,3528-7, 3568,3568-7)

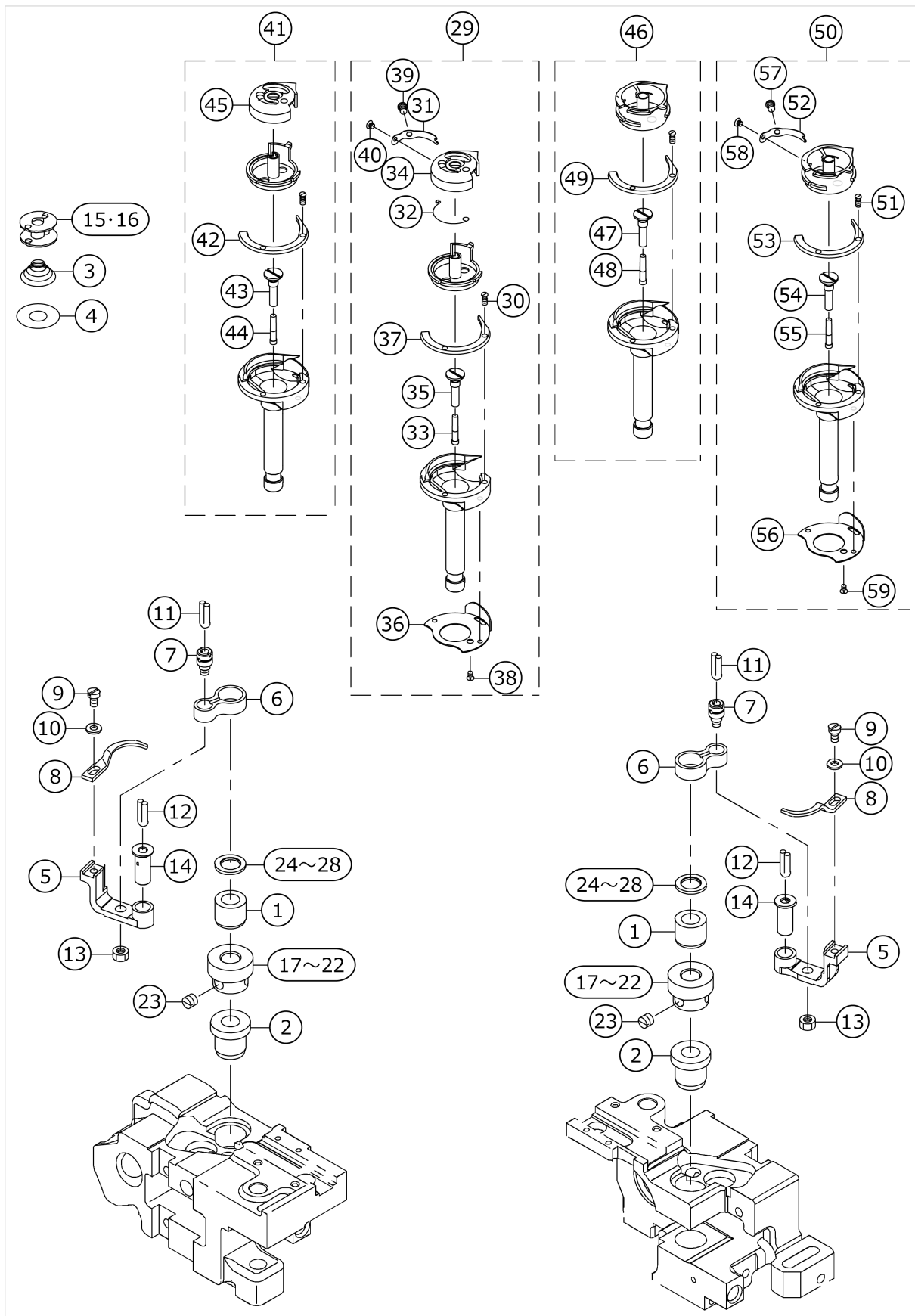

No.	品番	品名	備考	子部品	消耗品	個数
1	40042121	HOOK_UPPER_BUSH				2.00
2	40028491	HOOK_LOWER_BUSH				2.00
3	10111508	SPRING	FOR LH-3528-7,LH-3568-7			2.00
4	22653802	SHEET	FOR LH-3528-7,LH-3568-7			2.00
5	B1822051000	OPENING LEVER CRANK				2.00
6	B1820563000	BOBBIN CASE OPENING LEVER LINK				2.00
7	B1821051000	CRANK SCREW STUD				2.00
8	22613509	BOBBIN CASE OPENING LEVER				2.00
9	SS6090810TP	SCREW 9/64-40 L=7.5				2.00
10	WP0371016SD	WASHER 3.7X8X1				2.00
11	CQ202000000	OIL WICK				0.30
12	CQ202000000	OIL WICK				0.30
13	NS6110420SP	NUT 11/64-40				2.00
14	B1823051000	OPENING LEVER CRANK PIN				2.00
15	B9117051000	BOBBIN	FOR LH-3528,LH-3568			2.00
16	10210805	HARD ALUMITE BOBBIN	FOR LH-3528-7,LH-3568-7			2.00
17	40040549	HOOK_SHAFT_GEAR-E	SELECTIVE PARTS			2.00
18	40040550	HOOK_SHAFT_GEAR-F	SELECTIVE PARTS			2.00
19	40028560	HOOK_SHAFT_GEAR-A	SELECTIVE PARTS			2.00
20	40028561	HOOK_SHAFT_GEAR-B	SELECTIVE PARTS			2.00
21	40028562	HOOK_SHAFT_GEAR-C	SELECTIVE PARTS			2.00
22	40028563	HOOK_SHAFT_GEAR-D	SELECTIVE PARTS			2.00
23	SM8060550TP	SCREW M6 L=4.5				6.00
24	22614002	THRUST WASHER, A	SELECTIVE PARTS			2.00
25	22614101	THRUST WASHER, B	SELECTIVE PARTS			2.00
26	22614200	SPACER, C	SELECTIVE PARTS			2.00
27	10112605	THRUST WASHER 1.7	SELECTIVE PARTS			2.00
28	10112704	THRUST WASHER 1.8	SELECTIVE PARTS			2.00
29	40036684	ASSY-CAP_HOOK	FOR LH-3568			1.00
30	10112803	SCREW		*		1.00
31	22688402	TENSION ADJUSTING SPRING		*		1.00
32	22688204	SPRING		*		1.00
33	11015906	OIL WICK		*		1.00
34	22688154	BOBBIN CASE ASM.		*		1.00
35	40012805	TOP COVER R		*		1.00

36	22612303	NEEDLE POSITIONER		*		1.00
37	40036689	HOOK_GIB_TRIM		*		1.00
38	10112902	SCREW		*		1.00
39	22612907	TENSION ADJUSTING SCREW		*		1.00
40	10110500	TENSION SPRING INSTALLING SCREW		*		1.00
41	40036685	ASSY-CAP_HOOK_TRIM	FOR LH-3568-7			1.00
42	40036689	HOOK_GIB_TRIM		*		1.00
43	40012085	OIL_PLUG		*		1.00
44	11015906	OIL WICK		*		1.00
45	22688105	BOBBIN CASE		*		1.00
46	40036683	ASSY-RATCH_HOOK_TRIM	FOR LH-3528-7			1.00
47	40012085	OIL_PLUG		*		1.00
48	11015906	OIL WICK		*		1.00
49	40036689	HOOK_GIB_TRIM		*		1.00
50	40036682	ASSY-RATCH_HOOK	FOR LH-3528			1.00
51	10112803	SCREW		*		1.00
52	22612402	BOBBIN CASE TENSION SPRING		*		1.00
53	40036689	HOOK_GIB_TRIM		*		1.00
54	40012085	OIL_PLUG		*		1.00
55	11015906	OIL WICK		*		1.00
56	22612303	NEEDLE POSITIONER		*		1.00
57	10110609	TENSION ADJUSTING SCREW		*		1.00
58	10110500	TENSION SPRING INSTALLING SCREW		*		1.00
59	10112902	SCREW		*		1.00

# HOOK & HOOK DRIVING SHAFT COMPONENTS (2)(FOR LH-3578,3578-7, 3588,3588-7)

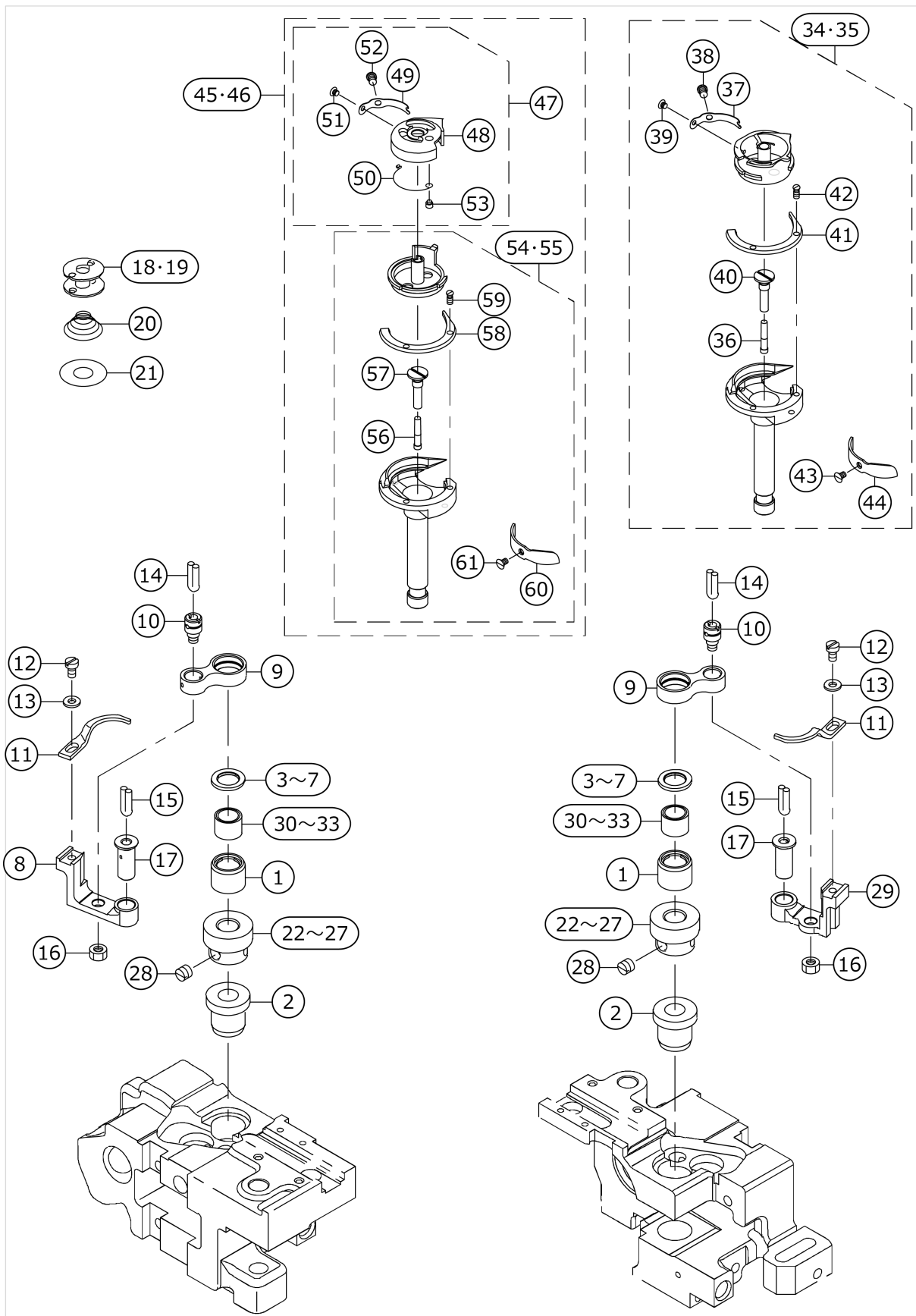

No.	品番	品名	備考	子部品	消耗品	個数
1	40050003	HOOK_SHAFT_BUSH_A				2.00
2	40028491	HOOK_LOWER_BUSH				2.00
3	10111201	THRUST WASHER, F	SELECTIVE PARTS			2.00
4	10109809	THRUST WASHER, B	SELECTIVE PARTS			2.00
5	10112506	THRUST WASHER 1.6	SELECTIVE PARTS			2.00
6	10111003	THRUST WASHER 1.2	SELECTIVE PARTS			2.00
7	10111102	THRUST WASHER 1.3	SELECTIVE PARTS			2.00
8	22813109	OPENING LEVER CRANK				1.00
9	22813000	BOBBIN CASE OPENING LEVER LINK				2.00
10	B1821051000	CRANK SCREW STUD				2.00
11	40057361	OPENING_LEVER				2.00
12	SS6090810TP	SCREW 9/64-40 L=7.5				2.00
13	WP0371016SD	WASHER 3.7X8X1				2.00
14	CQ202000000	OIL WICK				0.30
15	CQ202000000	OIL WICK				0.30
16	NS6110420SP	NUT 11/64-40				2.00
17	B1823051000	OPENING LEVER CRANK PIN				2.00
18	B9117563000	BOBBIN	FOR LH-3578,LH-3588			2.00
19	10231603	BOBBIN	FOR LH-3578-7,LH-3588-7			2.00
20	40055358	SPRING_L	FOR LH-3578-7,LH-3588-7			2.00
21	22819809	SHEET	FOR LH-3578-7,LH-3588-7			2.00
22	40028560	HOOK_SHAFT_GEAR-A	SELECTIVE PARTS			2.00
23	40028561	HOOK_SHAFT_GEAR-B	SELECTIVE PARTS			2.00
24	40028562	HOOK_SHAFT_GEAR-C	SELECTIVE PARTS			2.00
25	40028563	HOOK_SHAFT_GEAR-D	SELECTIVE PARTS			2.00
26	40040549	HOOK_SHAFT_GEAR-E	SELECTIVE PARTS			2.00
27	40040550	HOOK_SHAFT_GEAR-F	SELECTIVE PARTS			2.00
28	SM8060550TP	SCREW M6 L=4.5				6.00
29	40053371	INNERHOOK_GUIDE_ARM_R				1.00
30	SB30953010A	NEEDLE BEARING 9.525X9.52	SELECTIVE PARTS			2.00
31	SB30953010B	NEEDEL BEARING	SELECTIVE PARTS			2.00
32	SB30953010C	NEEDLE BEARING 9.525X9.52	SELECTIVE PARTS			2.00

33	SB30953010D	BEARING	SELECTIVE PARTS			2.00
34	40043333	ASSY_RATCH_LARGEHOOK	FOR LH-3578			1.00
35	40043334	ASSY_RATCH_LARGEHOOK(T)	FOR LH-3578-7			1.00
36	11404704	OIL WICK		*		1.00
37	22813802	BOBBIN CASE TENSION SPRING		*		1.00
38	10110609	TENSION ADJUSTING SCREW		*		1.00
39	10110500	TENSION SPRING INSTALLING SCREW		*		1.00
40	40012085	OIL_PLUG		*		1.00
41	40018978	HOOK_GIB		*		1.00
42	10112803	SCREW		*		1.00
43	22814008	SCREW		*		1.00
44	22813703	NEEDLE POSITIONER		*		1.00
45	40043335	ASSY_LARGEHOOK	FOR LH-3588			1.00
46	40043336	ASSY_LARGEHOOK(T)	FOR LH-3588-7			1.00
47	22827257	BOBBIN CASE ASM.		*		1.00
48	22827208	BOBBIN CASE		*		1.00
49	22827406	SPRING(0.3)		*		1.00
50	22827307	SPRING		*		1.00
51	10110500	TENSION SPRING INSTALLING SCREW		*		1.00
52	10110609	TENSION ADJUSTING SCREW		*		1.00
53	SS6560150SH	SCREW 3/32-80 L=1.3		*		1.00
54	40059786	LARGE HOOK EXCEPT CAP	FOR LH-3588	*		1.00
55	40059787	LARGE HOOK TRIM EXCEPT CAP	FOR LH-3588-7	*		1.00
56	11404704	OIL WICK		*		1.00
57	40012085	OIL_PLUG		*		1.00
58	40018978	HOOK_GIB		*		1.00
59	10112803	SCREW		*		1.00
60	22813703	NEEDLE POSITIONER		*		1.00
61	22814008	SCREW		*		1.00

# HOOK & HOOK DRIVING SHAFT COMPONENTS (3)

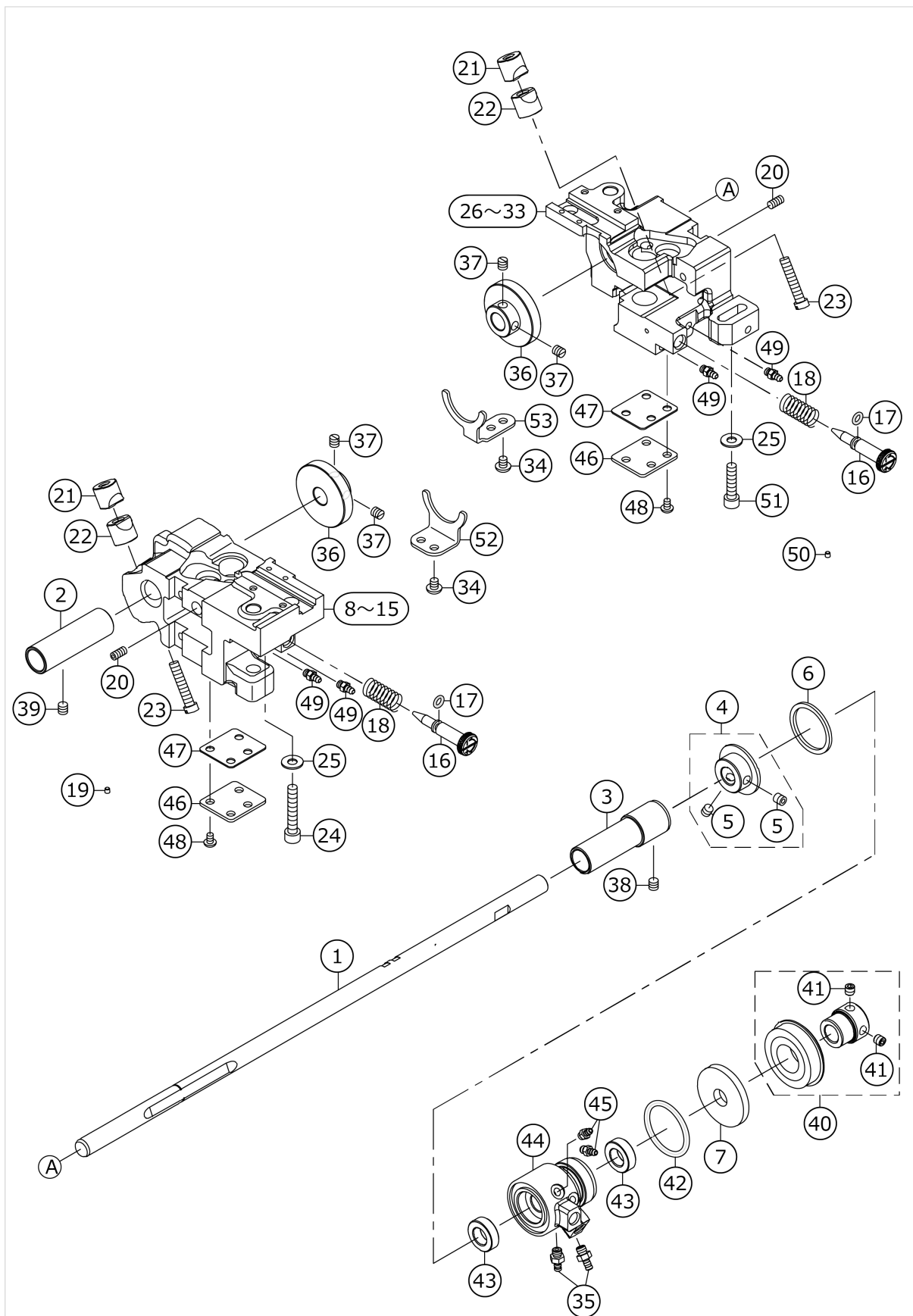

No.	品番	品名	備考	子部品	消耗品	個数
1	40028271	LOWER_SHAFT				1.00
2	40028851	LOWER_SHAFT_BUSH-F				1.00
3	40030915	LOWER_SHAFT_BUSH-M				1.00
4	40031351	ASSY-LOWER_SHAFT_COLLAR				1.00
5	SM8060612TP	SCREW M6 L=6		*		2.00
6	40013061	THRUST_WASHER				1.00
7	23618804	OIL SEAL				1.00
8	40028485	HOOK_SHAFT_BASE-L	FOR LH-3528,LH -3568(EXCEPT C HINA)			1.00
9	40028487	HOOK_SHAFT_BASE-L-TRIM	FOR LH-3528-7, LH-3568-7(EXCE PT CHINA)			1.00
10	40034969	HOOK_SHAFT_BASE_L	FOR LH-3528,LH -3568(CHINA)			1.00
11	40034971	HOOK_SHAFT_BASE_L-TRIM	FOR LH-3528-7, LH-3568-7(CHIN A)			1.00
12	40058117	L-HOOK_SHAFT_BASE-L	FOR LH-3578,LH -3588(EXCEPT C HINA)			1.00
13	40058119	L-HOOK_SHAFT_BASE-L-TRIM	FOR LH-3578-7, LH-3588-7(EXCE PT CHINA)			1.00
14	40043921	L-HOOK_SHAFT_BASE-L	FOR LH-3578,LH -3588(CHINA)			1.00
15	40043923	L-HOOK_SHAFT_BASE-L-TRIM	FOR LH-3578-7, LH-3588-7(CHIN A)			1.00
16	40042141	OIL_ADJUSTING_SCREW				2.00
17	RO044240100	RUBBER RING				2.00
18	40029570	OIL_ADJUSTING_SPRING				2.00
19	TA0290301M0	PLUG				6.00
20	SM8051002TP	SCREW M5 L=10				2.00
21	10109908	SADDLE INSTALLING BLOCK, UPPER				2.00
22	10112407	SADDLE INSTALLING BLOCK, LOWER				2.00
23	SS6153040SP	SCREW 15/64-28 L=30				2.00
24	SM6063750SP	SCREW M6 L=37				1.00
25	WP0621046SP	WASHER				2.00
26	40028486	HOOK_SHAFT_BASE-R	FOR LH-3528,LH -3568(EXCEPT C HINA)			1.00
27	40028488	HOOK_SHAFT_BASE-R-TRIM	FOR LH-3528-7, LH-3568-7(EXCE PT CHINA)			1.00
28	40034970	HOOK_SHAFT_BASE_R	FOR LH-3528,LH -3568(CHINA)			1.00
29	40034972	HOOK_SHAFT_BASE_R-TRIM	FOR LH-3528-7, LH-3568-7(CHIN A)			1.00



30	40058118	L-HOOK_SHAFT_BASE-R	FOR LH-3578,LH-3588(EXCEPT CHINA)			1.00
31	40058120	L-HOOK_SHAFT_BASE-R-TRIM	FOR LH-3578-7, LH-3588-7(EXCEPT CHINA)			1.00
32	40043922	L-HOOK_SHAFT_BASE-R	FOR LH-3578,LH-3588(CHINA)			1.00
33	40043924	L-HOOK_SHAFT_BASE-R-TRIM	FOR LH-3578-7, LH-3588-7(CHINA)			1.00
34	SM4050655SP	SCREW M5 L=6				4.00
35	SQ2060451MZ	CONNECTING SCREW				2.00
36	40028489	LOWER_SHAFT_GEAR				2.00
37	SM8060610TP	SCREW				4.00
38	SM8060612TP	SCREW M6 L=6				1.00
39	SM8060612TP	SCREW M6 L=6				1.00
40	40028656	ASSY-LOWER_SHAFT_BEARING				1.00
41	SM8060612TP	SCREW M6 L=6		*		2.00
42	RO257350100	O-RING				1.00
43	22888507	OIL SEAL				2.00
44	40011947	LOWER_PLUNGER_BUSH				1.00
45	SQ2050453MZ	CONNECTING SCREW				2.00
46	40022589	BOTTOM_COVER				2.00
47	40022590	BOTTOM_COVER_GASKET				2.00
48	SM4050855SP	SCREW				8.00
49	SQ2050453MZ	CONNECTING SCREW				4.00
50	TA0290301M0	PLUG				6.00
51	SM6062500SP	SCREW M6 L=25				1.00
52	40028495	GEAR_GUIDE-L				1.00
53	40028496	GEAR_GUIDE-R				1.00

# FEED MECHANISM COMPONENTS

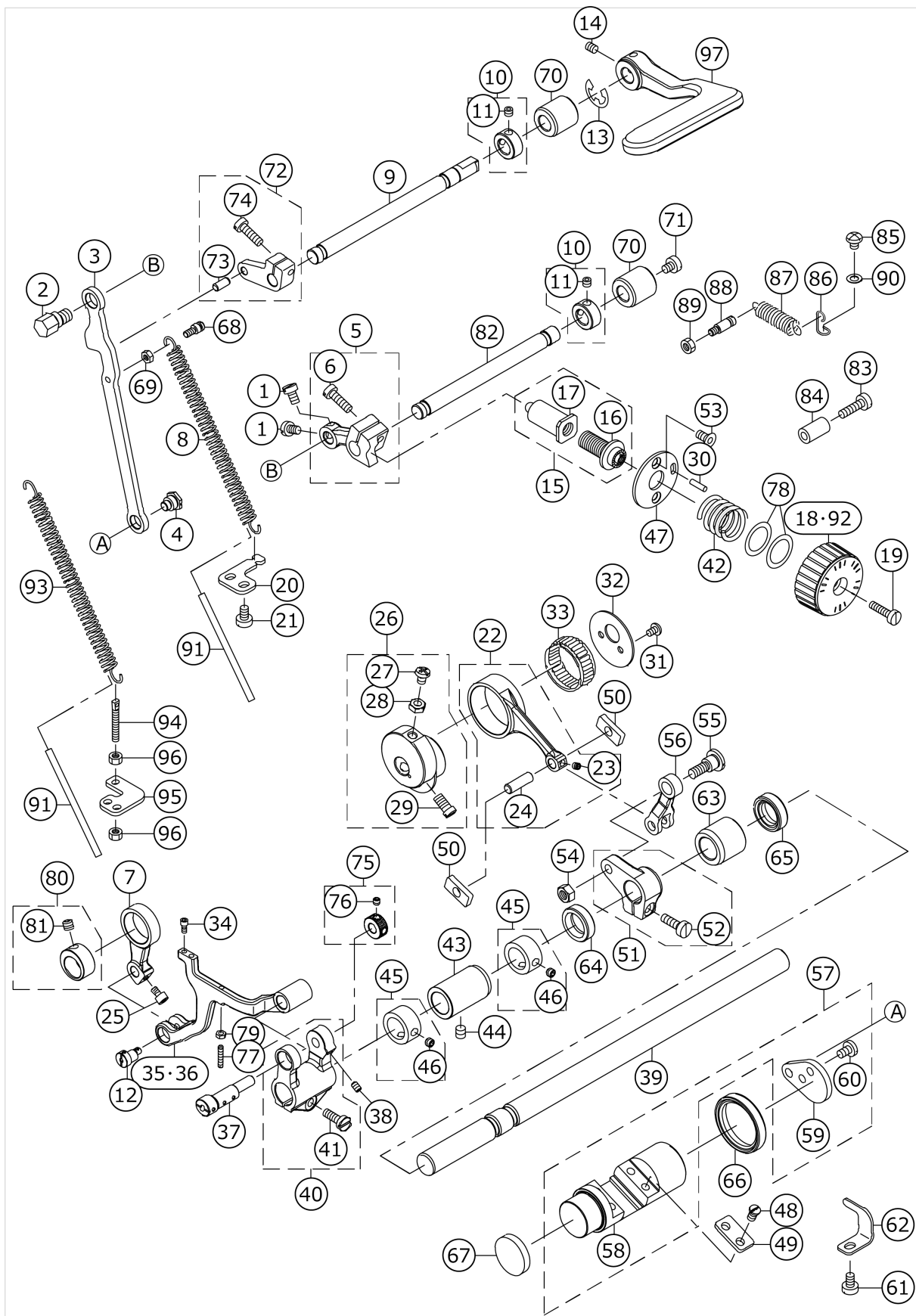

No.	品番	品名	備考	子部品	消耗品	個数
1	SM6050800SP	SCREW M5 L=8				2.00
2	40028293	FEED_REGULATOR_ROD_PIN				1.00
3	40028284	FEED_REGULATOR_ROD				1.00
4	SD0900426TP	SHOULDER SCREW D=9 H=4.2				1.00
5	40028854	ASSY_FEED_REGULATOR				1.00
6	SM6051600SP	SCREW M5 L=16		*		1.00
7	40011935	VERTICAL_FEED_LINK				1.00
8	22610307	FEED REGULATOR SPRING	FOR LH-3528,LH-3568,LH-3578, LH-3588			1.00
9	40028286	REVERSE_FEED_SHAFT				1.00
10	40032269	THRUST COLLAR				1.00
11	SM8050412TP	SCREW M5 L=4		*		2.00
12	40026673	VERTICAL_F_LINK_SHAFT_M				1.00
13	RE0900000K0	E-RING 9	FOR LH-3528-7, LH-3568-7,LH-3578-7,LH-3588-7			1.00
14	SM80506A2TP	SCREW M5 L=6	FOR LH-3528,LH-3568,LH-3578, LH-3588			1.00
15	40062651	FEED ADJUSTING SHAFT ASM				1.00
16	23533904	FEED ADJUSTING SCREW		*		1.00
17	40055569	FEED_ADJUSTING_SHAFT		*		1.00
18	40036433	FEED_DIAL				1.00
19	SS6121860SP	SCREW 3/16-28 L=18				1.00
20	40029079	SPRING_BRACKET	FOR LH-3528,LH-3568,LH-3578, LH-3588			1.00
21	SM6050800SP	SCREW M5 L=8				2.00
22	40032293	ASSY_FEED_ROCKER_ROD				1.00
23	SM8040412TP	SET SCREW M4 L=4		*		1.00
24	B1653470000	PIN		*		1.00
25	SM6750690TP	SCREW M3.5 L=6				1.00
26	40031348	ASSY_FD_ECCENTRIC_CAM				1.00
27	SM4051255SP	SCREW.,M5 L=12.		*		1.00
28	NM6050001SP	NUT M5		*		1.00
29	SM6061150TP	SCREW M6 L=11		*		2.00
30	PS0300122KH	SPRING PIN 3X12				1.00
31	SM4040655SP	SCREW M4 L=6				2.00
32	40011906	FD_CAM_LID				1.00
33	B1636581B00	NEEDLE BEARING B				1.00
34	SM6030672TP	SCREW M3 L=6				2.00
35	40011946	FEED_BASE	FOR LH-3528,LH-3568,LH-3578, LH-3588			1.00
36	40011934	FEED_BASE_TRIM	FOR LH-3528-7, LH-3568-7,LH-3578-7,LH-3588-7			1.00

37	40011932	FEED_BASE_SHAFT				1.00
38	SM8040612TP	SCREW M4 L=6				1.00
39	40028279	FEED_ROCKER_SHAFT				1.00
40	40031349	ASSY_FEED_BASE_ARM				1.00
41	SM6051400SP	SCREW		*		1.00
42	23534506	FEED DIAL SPRING				1.00
43	40011939	FEED_SHAFT_BUSH_F				1.00
44	SM8060612TP	SCREW M6 L=6				1.00
45	40032268	THRUST COLLAR				2.00
46	SM8050412TP	SCREW M5 L=4		*		2.00
47	40053172	FEED ADJUSTING BASE				1.00
48	SM7050850TP	SCREW M5 L=8				4.00
49	40028277	FEED_ADJUSTING_PLATE				2.00
50	40035704	FEED_ADJUSTING_BLOCK				2.00
51	40028852	ASSY_FEED_ROCKER_ARM				1.00
52	SM6051600SP	SCREW M5 L=16		*		1.00
53	SM1051052TN	SCREW M5 L=10				2.00
54	NM6060001CP	NUT M6				1.00
55	SD0900706TP	SHOULDER SCREW D=9 H=7				1.00
56	40036679	FEED_ROCKER_ARM_ROD				1.00
57	40028274	ASSY_FEED_ADJUSTING				1.00
58	40067594	FEED_ADJUSTING		*		1.00
59	40028276	FEED_ADJUSTING_ARM		*		1.00
60	SM7050850TP	SCREW M5 L=8		*		2.00
61	SM6050800SP	SCREW M5 L=8				1.00
62	40028281	FEED_ADJUSTING_STOPPER				1.00
63	40028280	FEED_SHAFT_BUSH_R				1.00
64	40013362	FEED_SHAFT_OIL_SEAL_A				1.00
65	40025316	FEED_SHAFT_OIL_SEAL_B				1.00
66	40028291	FEED_ADJUSTING_OIL_SEAL				1.00
67	40028294	FEED_ADJUSTING_CAP				1.00
68	40011926	SPRING_HOOK				1.00
69	NM6040001SP	NUT M4X0.7				1.00
70	40028287	REVERSE_FEED_SHAFT_BUSH				2.00
71	SM6050650TP	SCREW M5 L=6				1.00
72	40028855	ASSY_REVERSE_FEED_ARM				1.00
73	13319405	MAIN FEED ROCKER PIN		*		1.00
74	SM6051600SP	SCREW M5 L=16		*		1.00
75	40031350	ASSY_FEED_BASE_SAHFT_COLLAR				1.00
76	SM8040412TP	SET SCREW M4 L=4		*		2.00
77	SM8031612TP	SET SCREW M3X16				1.00
78	WP1751616SD	WASHER 17.5X24X1.6				2.00
79	NM6030001SN	NUT				1.00
80	40033668	ASSY_VERTICAL_FEED_CAM				1.00
81	SM8060552TP	SCREW M6 L=5		*		1.00
82	40028285	FEED_REGULATOR_SHAFT				1.00
83	SM6051850TP	SCREW M5 L=18				1.00
84	22952501	BACK LEVER STOPPER				1.00
85	SM4050655SP	SCREW M5 L=6				1.00
86	22656003	SPRING SUSPENSION				1.00
87	40040924	SPRING				1.00

88	40029257	SPRING_HOOK_B				1.00
89	NM6050001SP	NUT M5				1.00
90	WP0520656SA	WASHER 5.2X9.5X0.6				1.00
91	BT0500300EA	OIL TUBE				0.09
92	40050584	FEED DIAL 4	FOR LH-3528-0B ,LH-3528(TYPE F)			1.00
93	40062517	FEED_ADJUSTING_SPRING	FOR LH-3528-7, LH-3568-7,LH-3 578-7,LH-3588- 7			1.00
94	B1649161000	TENSION SPRING ADJUSTING SCREW	FOR LH-3528-7, LH-3568-7,LH-3 578-7,LH-3588- 7			1.00
95	40062489	SPRING_ADJUST_BRACKET	FOR LH-3528-7, LH-3568-7,LH-3 578-7,LH-3588- 7			1.00
96	NS6110420SP	NUT 11/64-40	FOR LH-3528-7, LH-3568-7,LH-3 578-7,LH-3588- 7			2.00
97	40033995	REVERSE_FEED_LEVER				1.00

# PRESSER BAR & TENSION RELEASE COMPONENTS

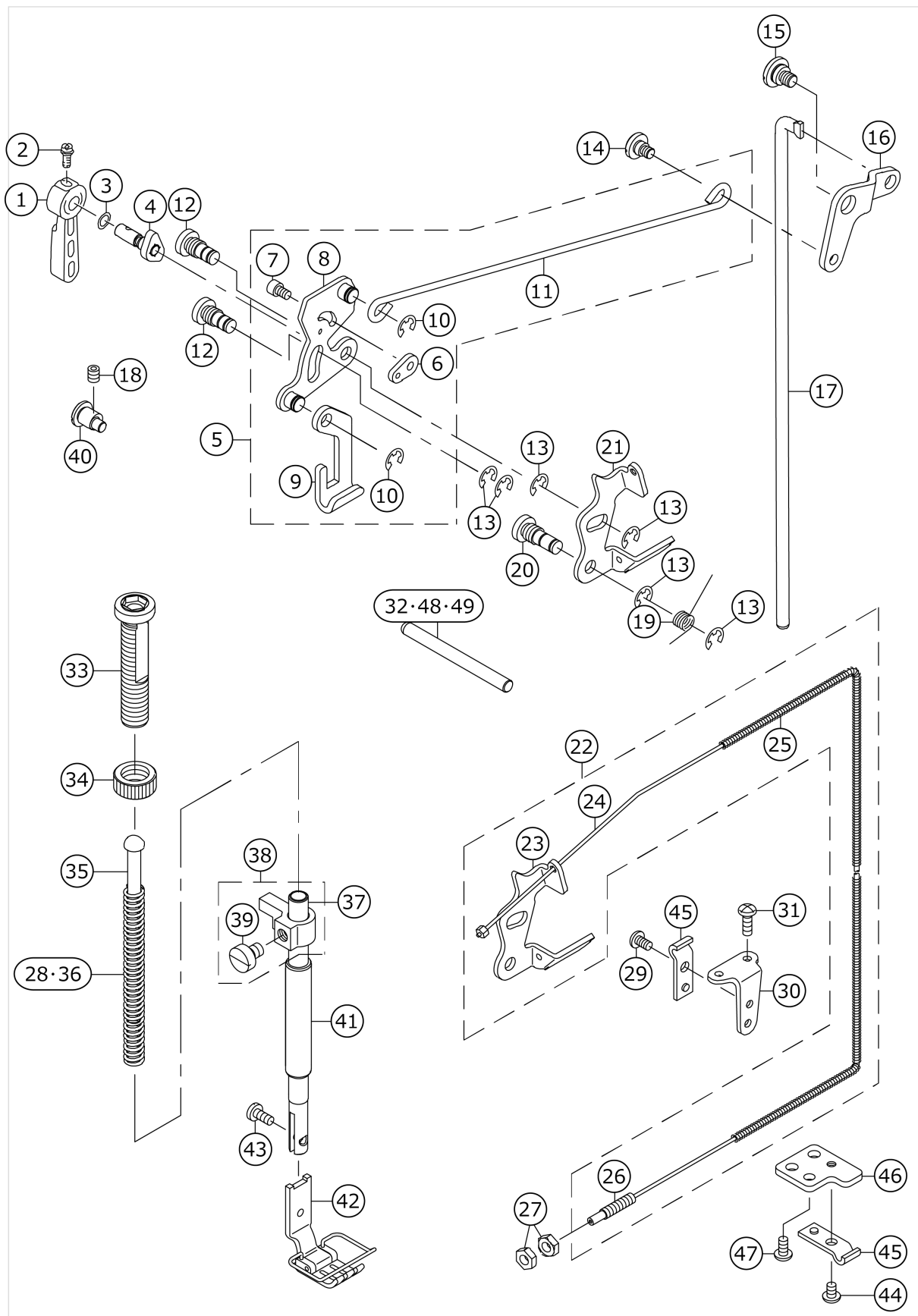

No.	品番	品名	備考	子部品	消耗品	個数
1	22907802	HAND LIFTER				1.00
2	B1521555000	SCREW				1.00
3	RO037180100	RUBBER RING				1.00
4	40035394	HAND_LIFTER_CAM_ASM.				1.00
5	40057398	ASSY LIFTING CONNECT ROD				1.00
6	23609605	PLATE		*		1.00
7	SM6040602TP	SCREW M4 L=6		*		1.00
8	40051384	ASSY HAND LIFTER LINK		*		1.00
9	22908008	LIFTING PLATE		*		1.00
10	RE0500000K0	E-RING		*		2.00
11	40035151	LIFTING_CONNECTING_ROD		*		1.00
12	40028545	LINK_SHAFT				2.00
13	RE0500000K0	E-RING				6.00
14	SD0640357TP	SHOULDER SCREW				1.00
15	SD0900356TP	SHOULDER SCREW D=9 H=3.5				1.00
16	40035181	LIFTING_LEVER_LINK				1.00
17	40028268	CONNECTING_ROD_A				1.00
18	SM8050612TP	SCREW M5X6				1.00
19	40053231	RETURN_SPRING				1.00
20	40028546	TENSION_RELEASE_SHAFT				1.00
21	40035298	TENSION_RELEASE_PLATE	FOR LH-3528,LH-3568,LH-3578,LH-3588			1.00
22	40035828	ASSY_TENSION_RELEASE_PLATE	FOR LH-3528-7,LH-3568-7,LH-3578-7,LH-3588-7			1.00
23	40035298	TENSION_RELEASE_PLATE		*		1.00
24	40033434	THREAD_TENSION_RELEASE_WIRE		*		1.00
25	40033435	WIRE_TUBE		*		1.00
26	D3159555B00	SET SCREW		*		1.00
27	NS6620310SP	NUT 3/16-32	FOR LH-3528-7,LH-3568-7,LH-3578-7,LH-3588-7			2.00
28	22907406	PRESSER SPRING	EXCEPT TYPE A			1.00
29	SS4110715SP	SCREW 11/64-40 L=7	FOR LH-3528-7,LH-3568-7,LH-3578-7,LH-3588-7			1.00
30	D3163555B00A	FLEXIBLE TUBE SUPPORT PLATE	FOR LH-3528-7,LH-3568-7,LH-3578-7,LH-3588-7			1.00
31	SS4111215SP	SCREW 11/64-40 L=12	FOR LH-3528-7,LH-3568-7,LH-3578-7,LH-3588-7			2.00
32	40034974	TENSION_RELEASE_SHAFT				1.00
33	23609209	PRESSER SPRING REGULATOR				1.00

34	22907604	PRESSER SPRING REGULATOR NUT				1.00
35	22907703	PRESSER GUIDE BAR				1.00
36	B1505227T00A	PRESSER SPRING	TYPE A			1.00
37	40028547	PRESSER BAR				1.00
38	40032272	ASSY_PRESSER BAR HOLDER				1.00
39	SM6060800SP	SCREW M6 L=8		*		1.00
40	40028269	LIFTER_ADJUSTING_PIN				1.00
41	23609001	BUSHING				1.00
42	22640551	PRESSER FOOT ASM.	EXCHANGING GAUGE PARTS(SEE.P.37 TO 45)			1.00
43	SS7090910TP	SCREW 9/64-40 L= 8.5				1.00
44	SM4040655SP	SCREW M4 L=6	FOR LH-3528-7, LH-3568-7,LH-3578-7,LH-3588-7			1.00
45	D3164555B00	OUTER PRESSER PLATE	FOR LH-3528-7, LH-3568-7,LH-3578-7,LH-3588-7			2.00
46	40050314	OUTER HOLDER_BASE	FOR LH-3528-7, LH-3568-7,LH-3578-7,LH-3588-7			1.00
47	SM4040855SP	SCREW	FOR LH-3528-7, LH-3568-7,LH-3578-7,LH-3588-7			1.00
48	40056685	PUSH BAR	SELECTIVE PARTS			1.00
49	40056686	PUSH BAR	SELECTIVE PARTS			1.00



# THREAD TRIMMER MECHANISM COMPONENTS (FOR LH-3528-7,3568-7,3578-7,3588-7)

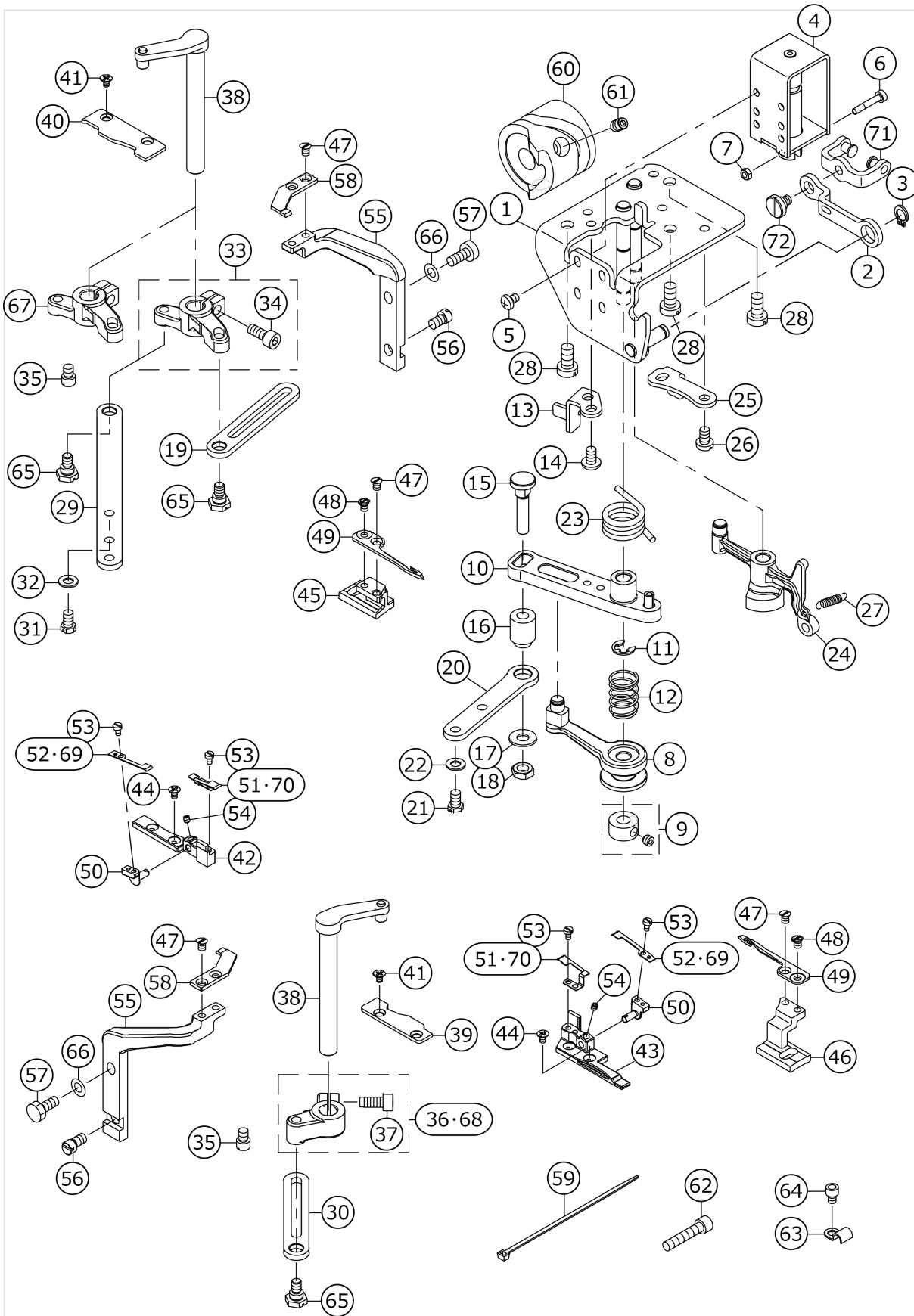

No.	品番	品名	備考	子部品	消耗品	個数
1	40017353	ASSY_BASE_PLATE				1.00
2	40065712	TRM_PUSH_LINK				1.00
3	RC0650811KP	RETAINING RING				1.00
4	40036359	THREAD_TRIMMER_SOLENOID				1.00
5	SM4040601SC	SCREW M4X0.7 L=6				4.00
6	23542418	CLUTCH LINK PIN				1.00
7	NM6030001SC	NUT M3				2.00
8	40017399	ASSY_TRM_ROLLER_ARM				1.00
9	40010434	THRUST_COLLAR_ASM.				1.00
10	11040854	KNIFE DRIVING ARM ASM.				1.00
11	RE0600000K0	E-RING 6				1.00
12	40017400	ROLLER_ARM_SPRING				1.00
13	40017361	TRM_DRIVING_ARM_STOPPER				1.00
14	SM4050855SP	SCREW				2.00
15	40017401	TRM_DRIVING_LINK_PIN				1.00
16	40017402	TRM_DRIVING_LINK_BUSH				1.00
17	WP0621046SP	WASHER				1.00
18	NM6060003SC	NUT M6				1.00
19	40012505	CONNECTING_ROD_B				1.00
20	40012506	CONNECTING_ROD_C				1.00
21	SM9050850SP	SCREW				2.00
22	WP0531000SD	WASHER M5				2.00
23	40017403	TRM_DRIVING_ARM_SPRING				1.00
24	40015669	ASSY_THREAD_RELEASE_ARM				1.00
25	40017362	RELEASE_ARM_STOPPER				1.00
26	SM4050855SP	SCREW				2.00
27	11305901	SPRING				1.00
28	SM6061200SP	SCREW				3.00
29	40012504	CONNECTING_ROD_A				1.00
30	40012505	CONNECTING_ROD_B				1.00
31	SM9050850SP	SCREW				2.00
32	WP0531000SD	WASHER M5				2.00
33	40031352	ASSY_KNIFE_DRIVING_ARM_R	FOR LH-3528-7,LH-3568-7			1.00
34	SM6051202TP	SCREW M5X0.8 L=12		*		1.00
35	40012503	KNIFE_DRIVING_ARM_PIN				2.00
36	40036446	ASSY_KNIFE_DRIVING_ARM_L	FOR LH-3528-7,LH-3568-7			1.00
37	SM6051202TP	SCREW M5X0.8 L=12		*		1.00
38	40012497	ASSY_KNIFE_BASE_SHAFT				2.00
39	40012492	D_KNIFE_BASE_GUIDE_L				1.00
40	40021883	D_KNIFE_BASE_GUIDE_R				1.00
41	SM1030501SN	SCREW M3 L=5				4.00
42	40021899	D_KNIFE_SUPPORT_R				1.00
43	40021898	D_KNIFE_SUPPORT_L				1.00
44	SM1030501SN	SCREW M3 L=5				4.00
45	40012488	DRIVING_KNIFE_BASE_R				1.00
46	40012487	DRIVING_KNIFE_BASE_L				1.00
47	SS1090520TP	SCREW 9/64-40 L=5				6.00
48	SS6090580TP	SCREW 9/64-40 L=4.5				2.00

49	40012403	DRIVING_KNIFE				2.00
50	40012495	CLAMP_SPRING_BASE				2.00
51	40044393	CLAMP				2.00
52	40033160	CLAMP_SPRING				2.00
53	SM6850400SP	SCREW M2.5 L=4				6.00
54	SM8030312TP	SCREW M3 L=3				2.00
55	40012489	FIXED_KNIFE_BASE				2.00
56	40012496	FIXED_KNIFE_BASE_ADJUST				2.00
57	SM9051203CP	SCREW M5 L=12				2.00
58	40012404	FIXED_KNIFE				2.00
59	EA9500B0100	CABLE BAND				2.00
60	40013316	THREAD_TRIMMER_CAM				1.00
61	SM8061010TP	SCREW				2.00
62	SM6052502TP	SCREW M5X0.8 L=25				1.00
63	B3538112000	OIL RETURN TUBE HOLDER				1.00
64	SM6040552TP	SCREW M4 L=4.5				1.00
65	SD0700346TP	SHOULDER SCREW D=7 H=3.4				3.00
66	WP0531000SD	WASHER M5				2.00
67	40021726	KNIFE_DRIVING_ARM_R_LH	FOR LH-3578-7,LH-3588-7			1.00
68	40026909	ASSY_KNIFE_DRIVING_ARM_L	FOR LH-3578-7,LH-3588-7			1.00
69	40076708	CLAMP_SPRING	OPTIONAL			2.00
70	40076709	CLAMP	OPTIONAL			2.00
71	40065722	ASSY_TRM_PUSH_LINK				1.00
72	SD0700336TP	SHOULDER SCREW				1.00

# AUTOMATIC REVERSE FEED MECHANISM COMPONENTS

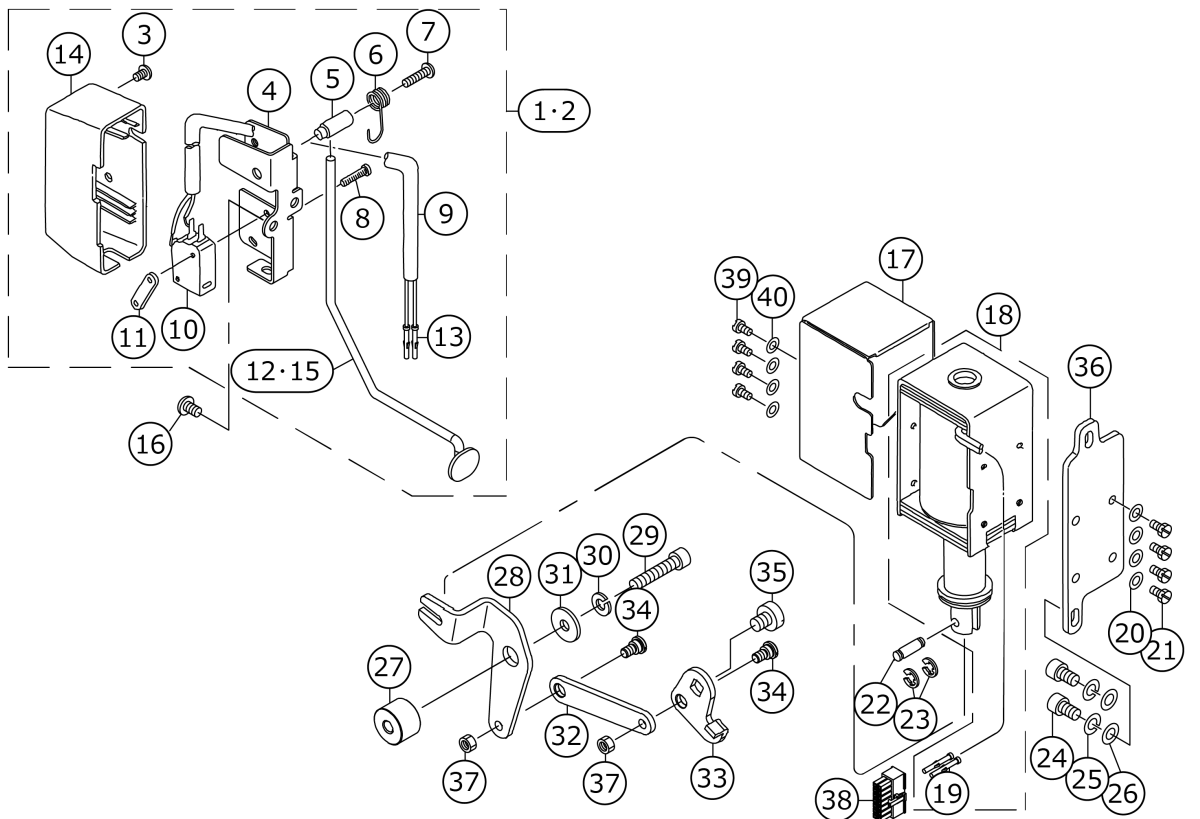

No.	品番	品名	備考	子部品	消耗品	個数
1	40033408	ASSY_REVERSE_FEED_SWITCH_28	FOR LH-3528-0B ,LH-3528-7,LH-3578-7			1.00
2	40035167	ASSY_REVERSE_FEED_SWITCH_68	FOR LH-3568-7,LH-3588-7			1.00
3	SM4040655SP	SCREW M4 L=6		*		1.00
4	22656508	REVERSE FEED SWITCH BASE		*		1.00
5	22954200	REVERSE FEED SWITCH SHAFT		*		1.00
6	22954309	REVERSE FEED SWITCH SPRING		*		1.00
7	SM4041655SP	SCREW M4 L=16		*		1.00
8	SM4031501SC	SCREW M3 L=15		*		2.00
9	HW500070000	2-CORE CABTYRE CORD		*		1.20
10	HA001900000	MICROSWITCH		*		1.00
11	22954408	STOPPER PLATE		*		1.00
12	40029027	REVERSE_FEED_SWITCH_LEVER	FOR LH-3528-0B ,LH-3528-7,LH-3578-7	*		1.00
13	HK03464000B	PIN CONTACT		*		2.00
14	22954606	REVERSE FEED SWITCH COVER		*		1.00
15	40035168	REVERSE_FEED_SWITCH_LEVER_68	FOR LH-3568-7,LH-3588-7	*		1.00
16	SM4050855SP	SCREW				2.00
17	10161305	SOLENOID COVER				1.00
18	40036360	REVERSE_FEED_SOLENOID				1.00
19	HK03464000B	PIN CONTACT		*		2.00
20	WP0501016SD	WASHER 5X10.5X1				4.00
21	SS9111010SP	SCREW 11/64-40 L=9.5				4.00
22	D2464555B00	LINK DRIVING MAGNET PIN				1.00
23	RE0400000K0	E-RING 4				2.00
24	SM6061202TP	SCREW M6 L=12				2.00
25	WS0631510KP	SPRING WASHER				2.00
26	WP0621016SD	WASHER 6.2X13X1				2.00
27	40030856	LINK_FULCULUM				1.00
28	40029350	REVERSE_FEED_LINK_L				1.00
29	SM6063002TP	SCREW M6 L=30				1.00
30	WS0610002KP	SPRING WASHER				1.00
31	WP0612056SD	WASHER 6.1X18.5X2				1.00
32	40035278	REVERSE_FEED_LINK_B				1.00
33	40035277	REVERSE_FEED_LINK_A				1.00
34	SD0700328TP	SHOULDER SCREW D=7 H=3.2				2.00
35	SM6050650TP	SCREW M5 L=6				1.00
36	10119204	SOLENOID INSTALLING PLATE				1.00
37	NM6050001SP	NUT M5				2.00
38	HK034610140	HOUSING 14P				1.00
39	SS7110710SP	SCREW 11/64-40 L=7				4.00
40	WP0501016SD	WASHER 5X10.5X1				4.00

# WIPER MECHANISM COMPONENTS (FOR LH-3528-7,3568-7,3578-7,3588

-7)

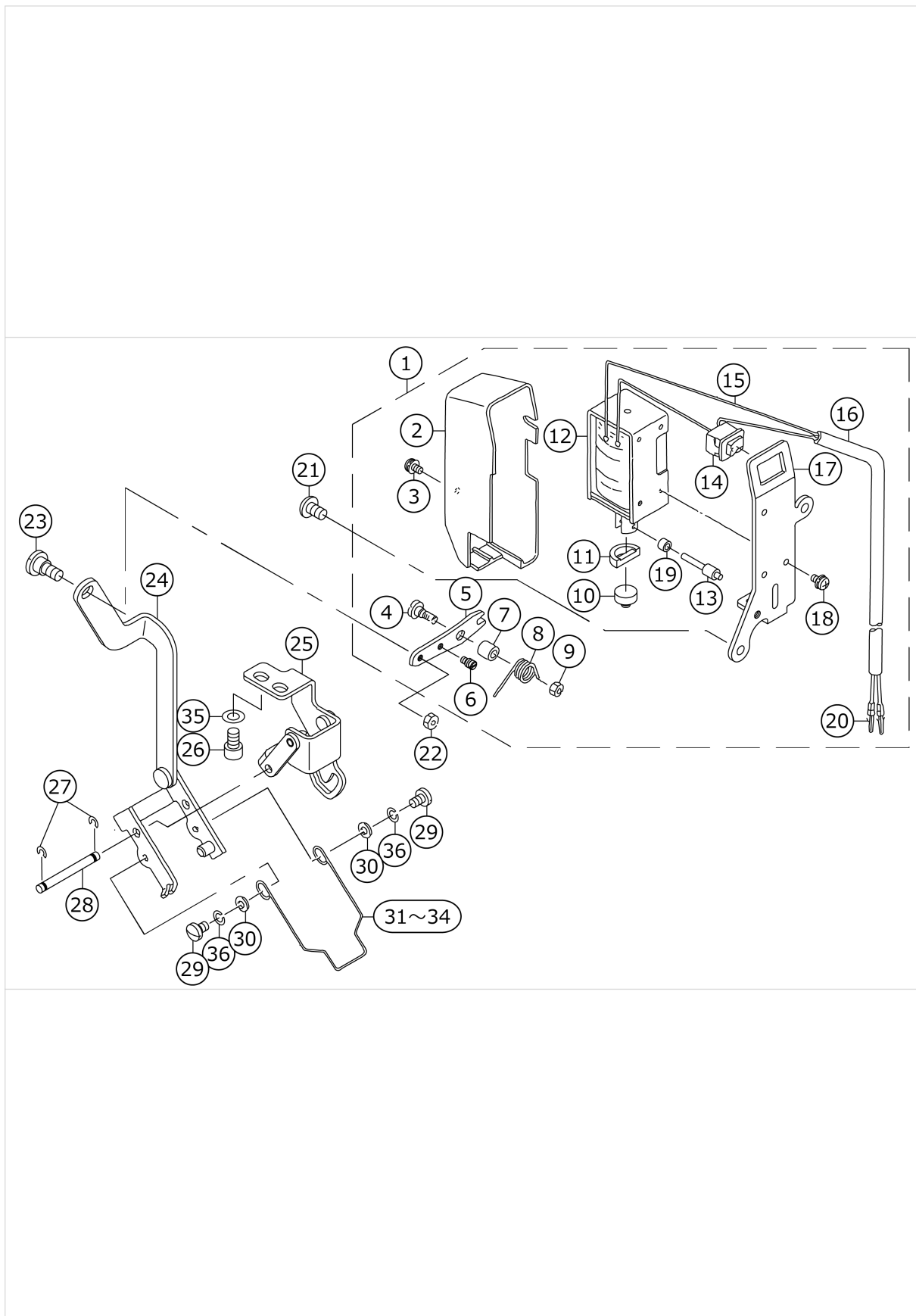

No.	品番	品名	備考	子部品	消耗品	個数
1	40033437	WIPER_SOLENOID_ASM.				1.00
2	22955504	WIPER COVER		*		1.00
3	SL4030631SC	SCREW M3X6		*		1.00
4	SD0650321TP	HINGE SCREW D=6.5 H=3.2		*		1.00
5	22657209	WIPER LINK, A		*		1.00
6	40009196	SUSPENSION SCREW		*		1.00
7	22956205	WIPER HINGE SCREW COLLAR		*		1.00
8	22657308	WIPER SPRING		*		1.00
9	NS6110310SP	NUT 11/64-40		*		1.00
10	22955900	WIPER RUBBER A		*		1.00
11	22956007	WIPER RUBBER B		*		1.00
12	40030956	WIPER_SOLENOID		*		1.00
13	22957104	WIPER SOLENOID SHAFT		*		1.00
14	HA000590000	POWER SWITCH		*		1.00
15	HW200390000	ELECTRIC WIRE		*		0.04
16	HW500070000	2-CORE CABTYRE CORD		*		1.10
17	40042151	WIPER_SOLENOID_BASE		*		1.00
18	SL4030641SE	SCREW		*		3.00
19	22957203	WIPER LINK COLLAR		*		1.00
20	HK03464000B	PIN CONTACT		*		2.00
21	SM4050855SP	SCREW				2.00
22	NS6090310SP	NUT 9/64-40				1.00
23	SD0500301SP	HINGE SCREW D= 5 H= 3				1.00
24	40028797	ASSY_WIPER_LINK_2				1.00
25	40028799	ASSY_WIPER_BASE				1.00
26	SM6050802TP	SCREW M5X0.8 L=8				2.00
27	RE0300000K0	E-RING 3				2.00
28	10208700	WIPER LINK SHAFT				1.00
29	SS7090610SP	SCREW 9/64-40 L=6				2.00
30	WP0371016SD	WASHER 3.7X8X1				2.00
31	10209203	WIPER 3/32-3/8	SELECTIVE PARTS			1.00
32	10209500	WIPER	SELECTIVE PARTS			1.00
33	10209807	WIPER	SELECTIVE PARTS			1.00
34	10209906	WIPER	SELECTIVE PARTS			1.00
35	WP0531000SD	WASHER M5				2.00
36	WS0410002KP	SPRING WASHER				2.00

# LUBRICATION COMPONENTS

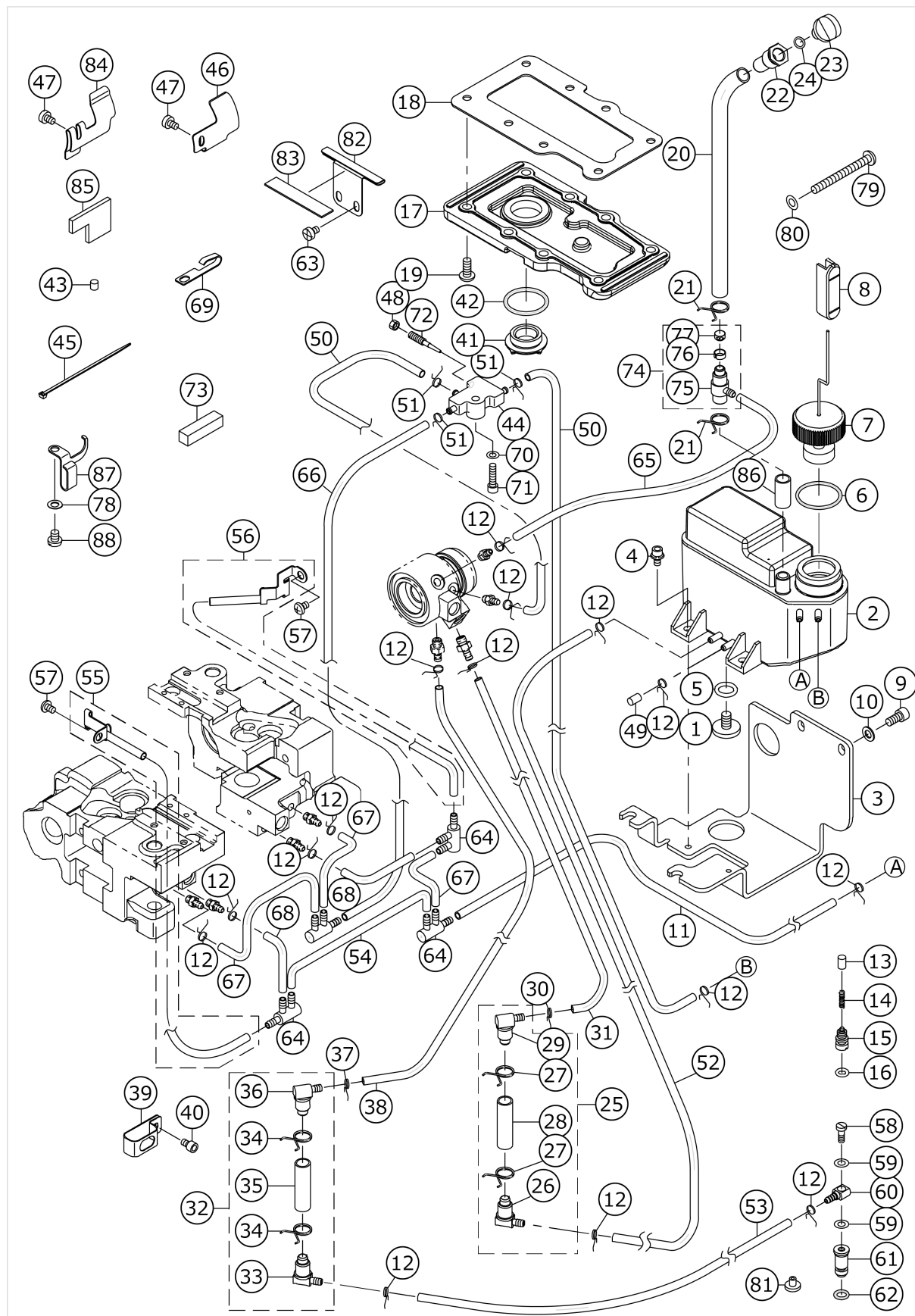



No.	品番	品名	備考	子部品	消耗品	個数
1	40028689	SCREW				1.00
2	40034926	OIL_TANK_ASM.				1.00
3	40034649	OIL_TANK_PLATE				1.00
4	SL6040892TN	BOLT				2.00
5	RO098240100	RUBBER RING				1.00
6	RO219200100	RUBBER RING				1.00
7	40028705	ASSY_FLOATER				1.00
8	40036167	OIL_GAGE				1.00
9	SM6051002TP	SCREW M5X0.8 L=10				2.00
10	WP0550800SP	WASHER 5.5X10X0.8				2.00
11	23630007	TUBE				0.48
12	23629306	PIPE STOPPER A				15.00
13	23628803	PLUNGER				2.00
14	23628902	PLUNGER SPRING				2.00
15	40013509	PLUNGER_SCREW				2.00
16	RO048190100	RUBBER RING				2.00
17	40028773	BOX_COVER				1.00
18	40028774	BOX_COVER_PACKING				1.00
19	SM4051255SP	SCREW.,M5 L=12				8.00
20	23630106	TUBE B				0.20
21	23629405	PIPE STOPPER B				2.00
22	40029075	LUBRICATING_INLET				1.00
23	40000344	LUBRICATING INLET CAP				1.00
24	RO048190100	RUBBER RING				1.00
25	40042287	ASSY_OIL_FILTER_R				1.00
26	23630601	OIL FILTER JOINT		*		1.00
27	23629405	PIPE STOPPER B		*		2.00
28	23630106	TUBE B		*		0.04
29	23630650	OIL FILTER JOINT ASM.		*		1.00
30	23629306	PIPE STOPPER A				1.00
31	23630007	TUBE				0.05
32	40042286	ASSY_OIL_FILTER_L				1.00
33	23630601	OIL FILTER JOINT		*		1.00
34	23629405	PIPE STOPPER B		*		2.00
35	23630106	TUBE B		*		0.05
36	23630650	OIL FILTER JOINT ASM.		*		1.00
37	23629306	PIPE STOPPER A				1.00
38	23630007	TUBE				0.06
39	40016749	TUBE HOLDER				1.00
40	SM6040602TP	SCREW M4 L=6				1.00
41	40034246	OIL_SIGHT_WINDOW				1.00
42	RO195240100	RUBBER RING				1.00
43	B3517009000	OIL FELT REAR				1.00
44	40032804	BASE				1.00
45	EA9500B0100	CABLE BAND				3.00
46	40039604	LUBRICATING_GUIDE	FOR LH-3528-7,LH-3578-7			1.00
47	SM6040650TP	SCREW				1.00
48	NS6110310SP	NUT 11/64-40				1.00
49	23540305	FLOATER CASE CAP				1.00

50	23630007	TUBE				0.23
51	10126803	OIL TUBE HOLDER				3.00
52	23630007	TUBE				0.20
53	23630007	TUBE				0.38
54	23630007	TUBE				0.07
55	40032405	ASSY_GEAR_OIL_WICK_LEFT				1.00
56	40032406	ASSY_GEAR_OIL_WICK_RIGHT				1.00
57	SM4050655SP	SCREW M5 L=6				2.00
58	B3525357000	CONNECTING SCREW (B)				1.00
59	B3534012000	GASKET				2.00
60	SQ0000401MZ	CONNECTING SCREW				1.00
61	40036333	SUCTION				1.00
62	RO037180100	RUBBER RING				1.00
63	SM6040655TP	SCREW M4 L=6				2.00
64	23629504	DISTRIBUTOR				4.00
65	23630007	TUBE				0.28
66	23630007	TUBE				0.33
67	23630007	TUBE				0.06
68	23630007	TUBE				0.03
69	26230409	LUBRICATING OIL WICK STOPPER				1.00
70	WP0430800SD	WASHER M4				1.00
71	SM6041602TP	SCREW M4X0.7 L=16				1.00
72	B1834512000	OIL ADJUSTING SCREW				1.00
73	22603708	FELT				1.00
74	40065984	ASSY_OIL_JOINT				1.00
75	40040809	OIL_JOINT		*		1.00
76	23630502	OIL FILTER RING		*		1.00
77	23630403	OIL FILTER		*		1.00
78	WP0520656SA	WASHER 5.2X9.5X0.6				1.00
79	SM4055001SF	SCREW M5 L=50				1.00
80	WP0531000SD	WASHER M5				1.00
81	40042086	CAP				1.00
82	40041578	RUBBER_PLATE				1.00
83	40041579	OIL_SHIELD_PLATE				1.00
84	23204803	LUBRICATING GUIDE	FOR LH-3568-7,LH-3588-7			1.00
85	40039625	LUBRICATING_FELT	FOR LH-3568-7,LH-3588-7			1.00
86	23630106	TUBE B				0.02
87	40035264	SPRING_HOOK				1.00
88	SM4050655SP	SCREW M5 L=6				1.00

# BELT COVER & BOBBIN WINDER COMPONENTS

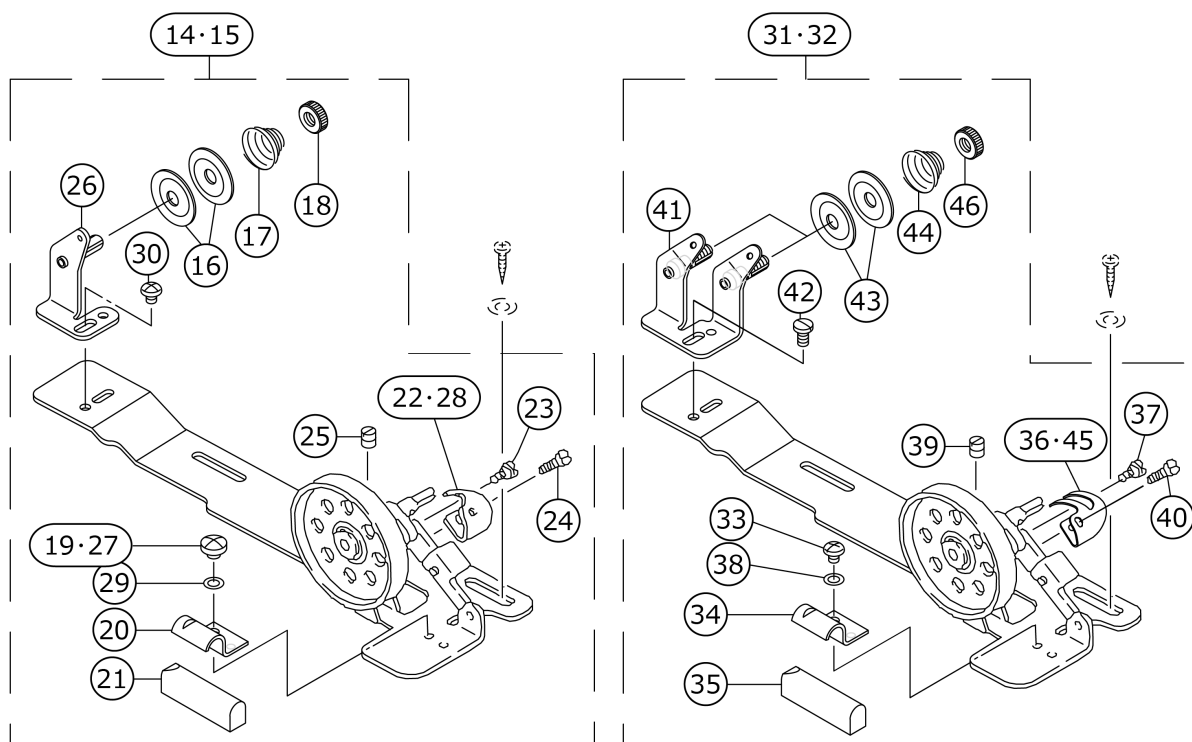
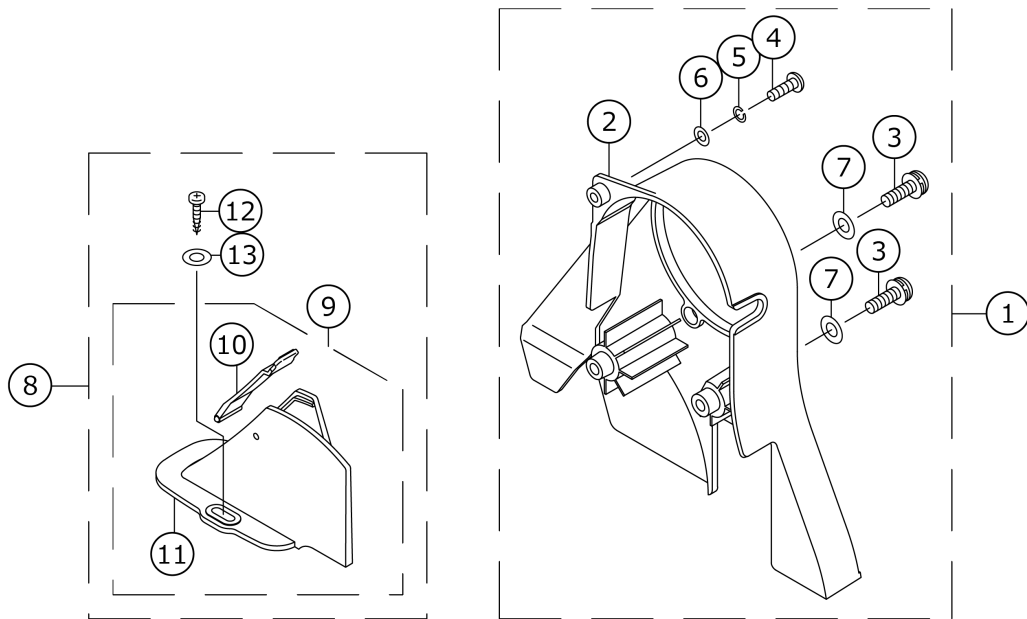

No.	品番	品名	備考	子部品	消耗品	個数
1	40033409	ASSY_BELT_COVER				1.00
2	40029905	BELT_COVER_A		*		1.00
3	SM4062001SC	SCREW M6 L=20		*		2.00
4	SM4051601SC	SCREW M5X0.8 L=16		*		1.00
5	WS0521010KN	SPRING WASHER 5.2X8.2X1		*		1.00
6	WP0531001SC	WASHER		*		1.00
7	WP0641600SC	WASHEW 6.4X12.5X1.6		*		2.00
8	40034267	ASSY_BELT_COVER_B				1.00
9	22933659	BELT COVER B COMPL.		*		1.00
10	22933758	BELT COVER B LID ASM.		*		1.00
11	22933600	BELT COVER B		*		1.00
12	SK3412000SC	WOOD SCREW D=4.1 L=20		*		2.00
13	WP0501016SC	WASHER 5X10.5X1		*		2.00
14	22927354	BOBBIN WINDER COMPL.	FOR LH-3528,LH -3528-7,LH-356 8,LH-3568-7			1.00
15	11415866	BOBBIN WINDER COMPL	FOR LH-3578,LH -3578-7,LH-358 8,LH-3588-7			1.00
16	22928907	THREAD TENSION DISK		*		2.00
17	22929004	THREAD TENSION SPRING		*		1.00
18	22928808	NUT		*		1.00
19	SS7110350SP	SCREW 11/64-40 L=3.5	FOR LH-3528,LH -3528-7,LH-356 8,LH-3568-7	*		1.00
20	22928402	CONTROL RUBBER HOLDING PLATE		*		1.00
21	22928303	CONTROL RUBBER		*		1.00
22	22928105	BOBBIN PRESSER	FOR LH-3528,LH -3528-7,LH-356 8,LH-3568-7	*		1.00
23	SD0490261SP	HINGE SCREW D=4.9 H=2.6		*		1.00
24	SS7081310SP	SCREW 1/8-44 L=12.5		*		1.00
25	SS8110510SP	SCREW 11/64-40 L=5		*		1.00
26	22928501	THREAD TENSION POST BASE		*		1.00
27	SS4110515SP	SCREW 11/64-40 L=5	FOR LH-3578,LH -3578-7,LH-358 8,LH-3588-7	*		1.00
28	11415908	POSITIONING FINGER	FOR LH-3578,LH -3578-7,LH-358 8,LH-3588-7	*		1.00
29	WP0480856SP	WASHER 4.8X8.4X0.8	FOR LH-3578,LH -3578-7,LH-358 8,LH-3588-7	*		1.00
30	SS4110515SP	SCREW 11/64-40 L=5		*		1.00
31	22837553	BOBBIN DEVICE	FOR LH-3578,LH -3578-7,LH-358 8,LH-3588-7(JE )			1.00
32	22621155	THREAD WINDER ASM.	FOR LH-3528,LH -3528-7,LH-356 8,LH-3568-7(JE )			1.00

33	SS4110515SP	SCREW 11/64-40 L=5		*		1.00
34	22928402	CONTROL RUBBER HOLDING PLATE		*		1.00
35	22928303	CONTROL RUBBER		*		1.00
36	22621106	BOBBIN PRESSER	FOR LH-3528,LH-3528-7,LH-3568,LH-3568-7(JE)	*		1.00
37	SD0490261SP	HINGE SCREW D=4.9 H=2.6		*		1.00
38	WP0480856SP	WASHER 4.8X8.4X0.8		*		1.00
39	SM8040502TP	SCREW M4X0.7 L=5		*		1.00
40	SS7081310SP	SCREW 1/8-44 L=12.5		*		1.00
41	22621056	TENSION BAR BASE		*		1.00
42	SS7110840SP	SCREW 11/64-40 L=7.8		*		1.00
43	22928907	THREAD TENSION DISK		*		4.00
44	22929004	THREAD TENSION SPRING		*		2.00
45	22837504	BOBBIN PRESSER	FOR LH-3578,LH-3578-7,LH-3588,LH-3588-7(JE)	*		1.00
46	22928808	NUT		*		2.00

# BOTTOM COVER COMPONENTS

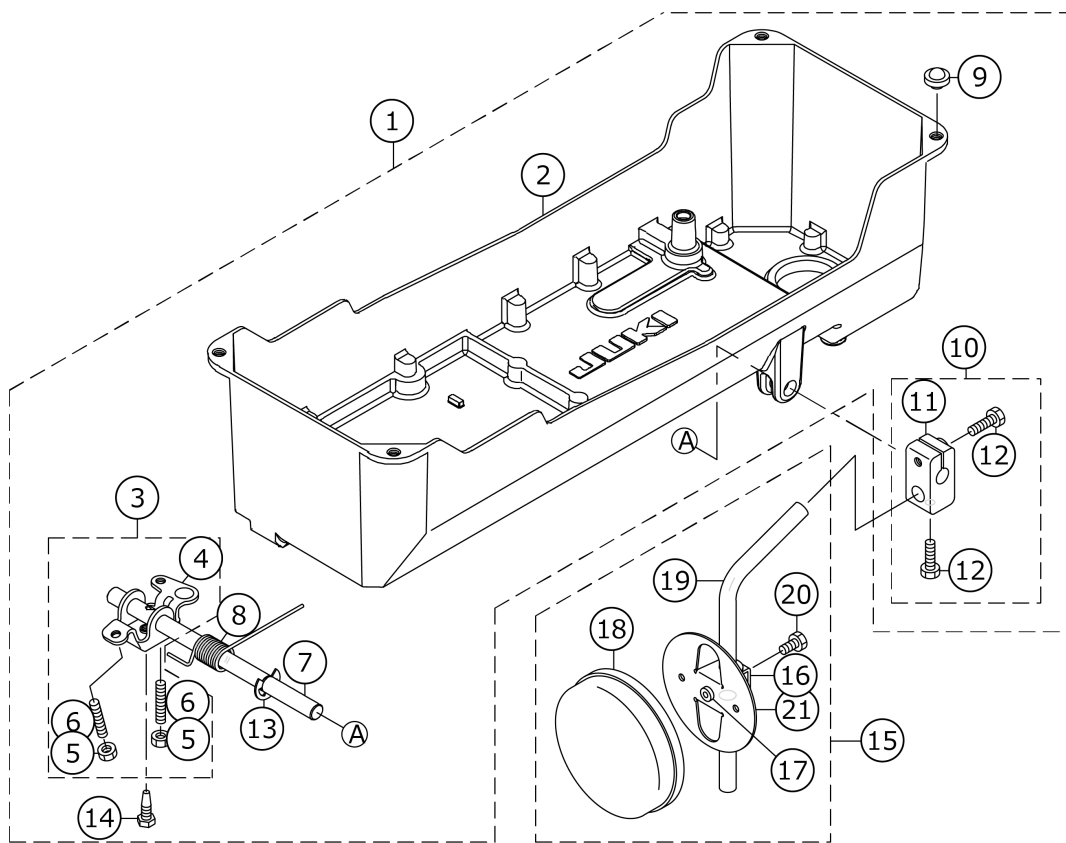

No.	品番	品名	備考	子部品	消耗品	個数
1	40032107	ASSY_BOTTOM_COVER_A				1.00
2	40028778	BOTTOM_COVER		*		1.00
3	40034853	CONNECTING_ROD_ASM		*		1.00
4	22932107	KNEE LIFTING ROTATING ARM		*		1.00
5	NM6060001SE	NUT M6		*		2.00
6	SM8063012TR	SCREW M6 L=30		*		2.00
7	40025191	KNEE_PRESS_ROD		*		1.00
8	22932206	SPRING		*		1.00
9	B1116210D00	FRAME SUPPORT RUBBER		*		4.00
10	22932453	BRACKET ASM.		*		1.00
11	22932404	BRACKET		*		1.00
12	22934707	SCREW		*		2.00
13	RE1000000K0	E-RING 10		*		1.00
14	SM9061853SR	SCREW M6 L=17.5		*		1.00
15	22934251	KNEE PAD PLATE ASM.	ACCESSORIE PARTS			1.00
16	22934301	KNEE PAD PLATE SUPPORT		*		1.00
17	22934400	KNEE PAD PLATE RUBBER		*		1.00
18	22934509	KNEE PAD PLATE COVER		*		1.00
19	22934608	KNEE PAD UPRIGHT SHAFT		*		1.00
20	SM9061203SE	SCREW M6 L=12		*		1.00
21	22934202	KNEE PAD PLATE		*		1.00

# AK DEVICE COMPONENTS

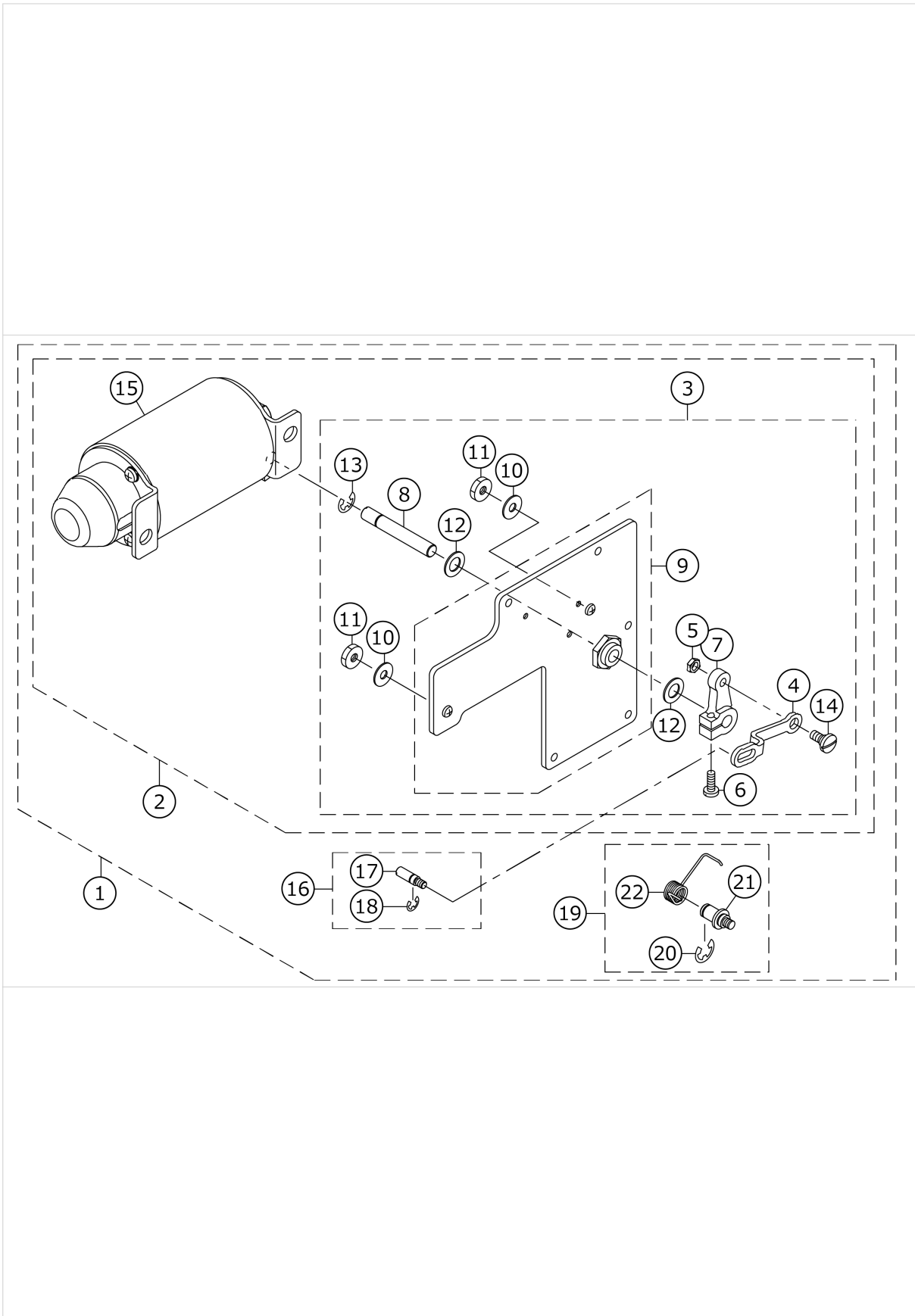



No.	品番	品名	備考	子部品	消耗品	個数
1	40055883	AK135				1.00
2	40036221	ASSY_AK_DEVICE		*		1.00
3	40036222	COMP_REAR_PLATE		*		1.00
4	40030962	SOLENOID_LINK		*		1.00
5	NS6150310SP	NUT 15/64-28		*		1.00
6	SS7121410TP	SCREW 3/16-28 L=14		*		1.00
7	GAK33027000	SOLENOID ARM		*		1.00
8	22991400	SOLENOID SHAFT		*		1.00
9	40036223	ASSY_REAR_PLATE		*		1.00
10	WP0621036SP	WASHER		*		2.00
11	NS6150440SP	NUT 15/64-28		*		2.00
12	WP1021016SD	WASHER		*		2.00
13	RE0700000K0	E-RING 7		*		1.00
14	SD0800352SP	HINGE SCREW D= 8 H= 3.5		*		1.00
15	GAKA18300B0	AK SOLENOID ASM.,B		*		1.00
16	40059504	ASSY SHAFT_PIN		*		1.00
17	40030954	SHAFT_PIN		*		1.00
18	RE0500000K0	E-RING		*		1.00
19	40059505	ASSY AK PIN		*		1.00
20	RE0800000K0	E-SHAPED SNAP RING (8MM)		*		1.00
21	40056385	AK_LINK_SHAFT		*		1.00
22	40056438	AK_RETURN_SPRING		*		1.00

# THREAD STAND COMPONENTS

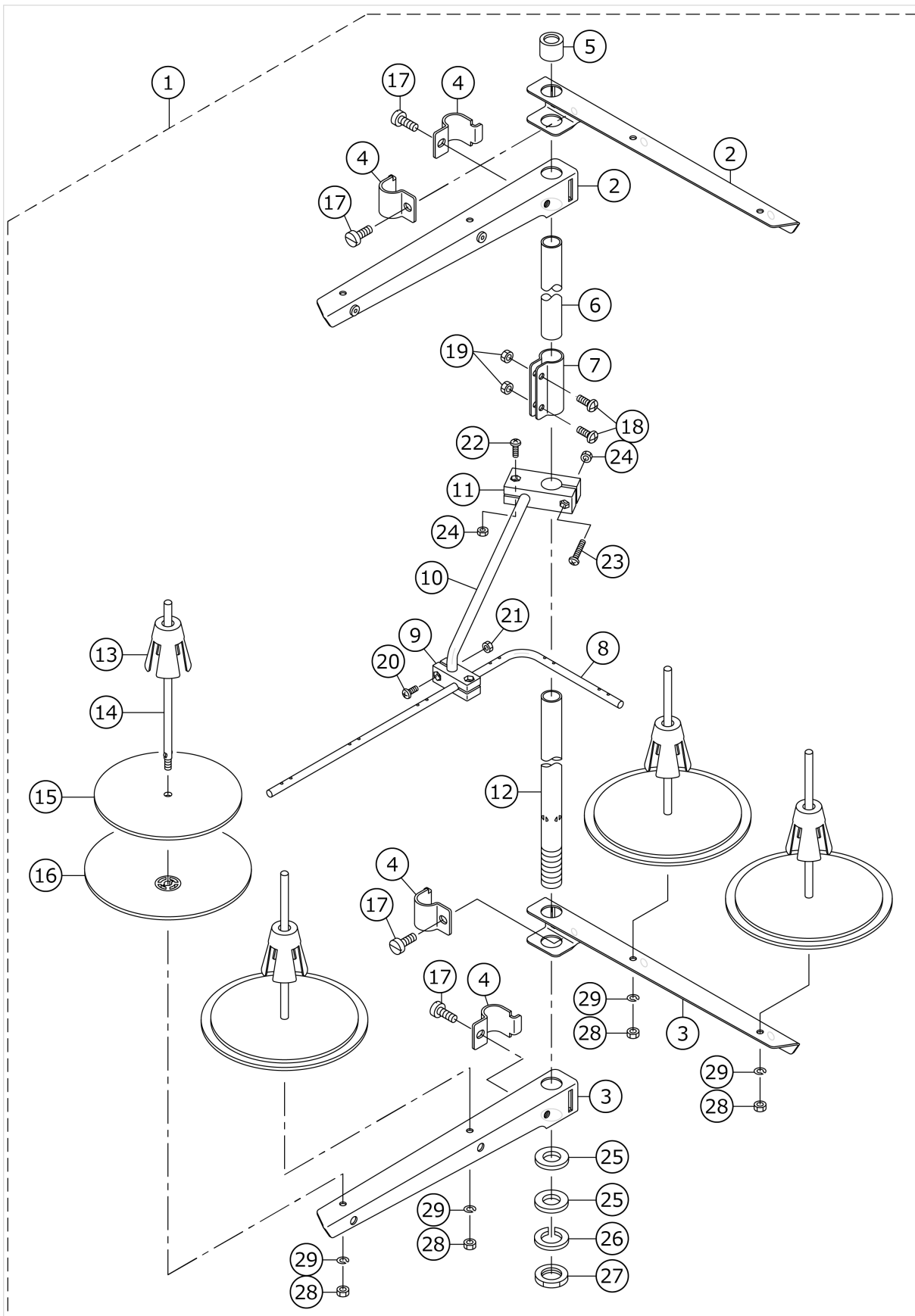

No.	品番	品名	備考	子部品	消耗品	個数
1	13167556	THREAD STANDING DEVICE ASM.				1.00
2	22930556	SPOOL REST ARM ASM.		*		2.00
3	22930507	SPOOL REST ARM		*		2.00
4	22930705	THREAD GUIDE ARM JOINT		*		4.00
5	22931406	THREAD STANDING ROD RUBBER CAP		*		1.00
6	22930408	THREAD STANDING ROD, UPPER		*		1.00
7	22931307	THREAD STANDING ROD JOINT		*		1.00
8	13167903	THREAD STANDING THREAD GUIDE		*		1.00
9	13168000	THREAD STANDING GUIDE BASE		*		1.00
10	13168109	THREAD STANDING GUIDE ARM		*		1.00
11	13168208	THREAD STANDING GUIDE ARM BASE		*		1.00
12	22930309	THREAD STANDING ROD, LOWER		*		1.00
13	22931109	SPOOL RETAINER		*		4.00
14	22931000	SPOOL PIN		*		4.00
15	22930903	SPOOL REST CUSHION		*		4.00
16	22930804	SPOOL REST		*		4.00
17	SM6061610SC	SCREW M6 L=16		*		4.00
18	SM4051405SE	SCREW M5 L=14		*		2.00
19	NM6050001SE	NUT M5		*		2.00
20	SM4041001SC	SCREW M4X0.7 L=10		*		2.00
21	NM6040002SE	NUT M4X0.7		*		2.00
22	SM4041201SC	SCREW M4 L=12		*		1.00
23	SM4042001SC	SCREW M4 X 20		*		1.00
24	NM6040002SE	NUT M4X0.7		*		2.00
25	WP1612616SE	WASHER 16X30X2.6		*		2.00
26	WS1643202KR	SPRING WASHER		*		1.00
27	NM6160511SE	NUT M16X1.5		*		1.00
28	NM6050001SE	NUT M5		*		4.00
29	WS0510002KN	SPRING WASHER		*		4.00



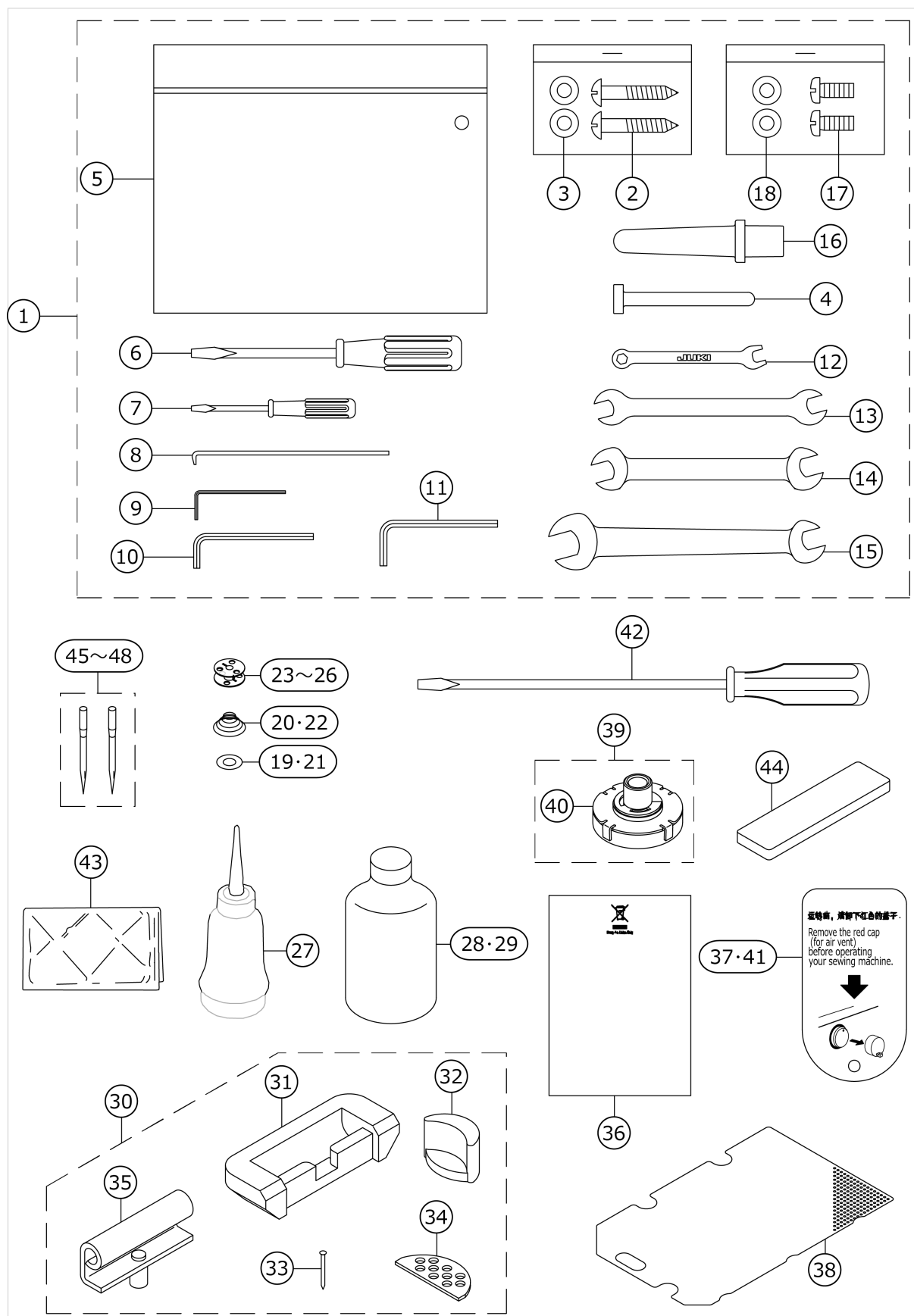

# ACCESSORIE PARTS COMPONENTS







No.	品番	品名	備考	子部品	消耗品	個数
1	40033439	ACCESSORIE_BAG_ASM.				1.00
2	SK3482501SE	WOOD SCREW D=4.8 L=25		*		2.00
3	WP0501016SC	WASHER 5X10.5X1		*		2.00
4	40056705	KNEE_LIFTER_PRESSER_ROD		*		1.00
5	22932800	ACCESSORIE BAG		*		1.00
6	22933105	SCREW DRIVER,MIDDLE		*		1.00
7	22933204	SCREW DRIVER,SMALL		*		1.00
8	B9101490000	DRIVER		*		1.00
9	12455507	HEXAGONAL WRENCH, 1.5		*		1.00
10	12455705	HEXAGONAL WRENCH, 2.5		*		1.00
11	B9141372000	HEXAGONAL WRENCH, LARGE		*		1.00
12	13160106	SPANNER (5X6)		*		1.00
13	26034801	WRENCH (7X8)		*		1.00
14	26233700	WRENCH		*		1.00
15	26034702	WRENCH (14X11)		*		1.00
16	22931604	FRAME SUPPORT BAR		*		1.00
17	SM4051255SP	SCREW.,M5 L=12.		*		2.00
18	WP0531000SC	WASHER 5.3X10X1		*		2.00
19	22819809	SHEET	FOR LH-3578-7,LH-3588-7			1.00
20	40055358	SPRING_L	FOR LH-3578-7,LH-3588-7			1.00
21	22653802	SHEET	FOR LH-3528-7,LH-3568-7			1.00
22	10111508	SPRING	FOR LH-3528-7,LH-3568-7			1.00
23	10210805	HARD ALUMITE BOBBIN	FOR LH-3528-7,LH-3568-7			2.00
24	B9117051000	BOBBIN	FOR LH-3528,LH-3568			2.00
25	10231603	BOBBIN	FOR LH-3578-7,LH-3588-7			2.00
26	B9117563000	BOBBIN	FOR LH-3578,LH-3588			2.00
27	B91210120A0	OILER ASM.				1.00
28	MML007600CA	JUKI MACHINE OIL 7				1.00
29	MDFRX1600C0	DEFRIX OIL NO.1(600CC)	EXCEPT CHINA			1.00
30	22926059	RUBBER HINGE ASM.				1.00
31	22926000	RUBBER CUSHION		*		2.00
32	22926109	FRAME RUBBER CUSHION		*		2.00
33	22926208	NAIL		*		8.00
34	22926505	WASHER		*		2.00
35	22926356	HINGE COMPL.		*		2.00
36	CM600100201	WEEE INFORMATION SHEET	FOR JE			2.00
37	40037488	SHEET	FOR CHINA			1.00
38	40030768	OIL_FILTER				1.00
39	40036428	ASSY_FILTER_A				1.00
40	40036125	FILTER		*		1.00
41	23640006	SHEET	EXCEPT CHINA			1.00
42	22933006	SCREW DRIVER,LARGE				1.00

43	22933303	VINYL COVER				1.00
44	40035873	FILTER_B				1.00
45	MDP500B1002	NEEDLE DPX5 #10-2	TYPE F			1.00
46	MDP500B1402	NEEDLE DPX5#14-2	TYPE S			1.00
47	MDP500B2102	DPX5#21-2	TYPE G			1.00
48	MDP500B0902	NEEDLE DPX5#9-2	TYPE A			1.00

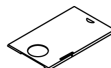
# TABLE OF EXCHANGING GAUGE PARTS (1)(FOR LH-3528)

Needle gauge size 針 幅		Presser foot asm. 押 さ え(組)										Swivel guide Presser asm. スイブルガイド 押さえ(組)		
Code コード			(Tip-divided) (移動式先割れ) 2.0mm		(Tip-divided) (移動式先割れ) 2.4mm		(Lower feed) (下送り)							
			No.	Part No.	No.	Part No.	No.	Part No.	No.	Part No.	No.	Part No.	No.	Part No.
A	3/32	2.4	(1)	226-37557	—	—	—	—	—	—	—	—		
B	1/8	3.2	(2)	226-37656	(15)	400-35896	(15)	400-35896	(50)	103-91852	(57)	226-27152	(63)	226-47051
C	5/32	4.0	(3)	226-37755	(16)	400-35897	(33)	400-71909	—	—	—	—	—	—
D	3/16	4.8	(4)	226-37854	(17)	226-40353	(34)	228-16557	(51)	103-92058	(58)	226-27350	(64)	226-47150
E	7/32	5.6	—	—	(18)	226-40452	(35)	228-16656	—	—	(59)	226-27459	(65)	226-47259
F	1/4	6.4	(5)	226-38050	(19)	226-40551	(36)	228-16755	(52)	103-92256	(60)	226-27558	(66)	226-47358
G	9/32	7.1	(6)	226-38258	(20)	226-40759	(37)	228-16854	—	—	(61)	226-27657	(67)	226-47457
H	5/16	7.9	(7)	226-38357	(21)	226-40858	(38)	228-16953	—	—	(62)	226-27756	(68)	226-47556
K	3/8	9.5	(8)	226-38456	(22)	226-40957	(39)	228-17050	—	—	—	—	—	—
W	7/16	11.1	—	—	(23)	226-41054	(40)	400-33941	—	—	—	—	—	—
L	1/2	12.7	(9)	226-38753	(24)	226-41252	(41)	228-17159	(53)	103-92751	—	—	—	—
M	5/8	15.9	—	—	(25)	226-41351	(42)	400-33945	—	—	—	—	—	—
N	3/4	19.1	(10)	226-38951	(26)	226-41450	(43)	400-33947	(54)	103-93056	—	—	—	—
P	7/8	22.2	(11)	226-39157	(27)	226-41658	(44)	400-33949	(55)	228-44450	—	—	—	—
Q	1	25.4	(12)	226-39256	(28)	226-41757	(45)	400-33951	(56)	228-44559	—	—	—	—
R	1-1/8	28.6	(13)	226-39355	(29)	226-41856	(46)	400-33953	—	—	—	—	—	—
S	1-1/4	31.8	(14)	226-39454	(30)	226-41955	(47)	400-33955	—	—	—	—	—	—
T	1-3/8	34.9	—	—	(31)	226-42052	(48)	400-33957	—	—	—	—	—	—
U	1-1/2	38.1	—	—	(32)	226-42151	(49)	400-33959	—	—	—	—	—	—
Stitch spec. 縫 仕 様	A	★												
	F													
	S	★												
	G	★												
下送り	★													

Needle gauge size 針 幅		Sliding plate asm. (Left) 滑り板(左)組		Sliding plate asm. (Right) 滑り板(右)組		Sliding plate asm. (Front) 滑り板(前)組		Sliding plate asm. (Left) 滑り板(左)組			
Code コード							Option オプション	No.	Part No.		
										No.	Part No.
A	3/32	2.4									
B	1/8	3.2									
C	5/32	4.0									
D	3/16	4.8									
E	7/32	5.6	(69)	226-01058	(73)	226-00555		(79)	400-51633		
F	1/4	6.4									
G	9/32	7.1									
H	5/16	7.9									
K	3/8	9.5									
W	7/16	11.1				(77)	400-42874	(78)	232-06709		
L	1/2	12.7									
M	5/8	15.9	(70)	226-01157	(74)	226-00654		(80)	400-45729		
N	3/4	19.1									
P	7/8	22.2									
Q	1	25.4	(71)	226-01256	(75)	226-00753		(81)	400-45730		
R	1-1/8	28.6									
S	1-1/4	31.8									
T	1-3/8	34.9	(72)	226-01355	(76)	226-00852		(82)	400-45731		
U	1-1/2	38.1									
Stitch spec. 縫 仕 様	A	Spec.common		Spec.common		Spec.common		★(テ-プ 付け)		Spec.common	
	F	仕様 共 通		仕様 共 通		仕様 共 通				仕様 共 通	
	S										
	G										
下送り											

No.	品番	品名	備考	子部品	消耗品	個数
1	22637557	PRESSER FOOT ASM.				1.00
2	22637656	PRESSER FOOT ASM.				1.00
3	22637755	PRESSER FOOT ASM.				1.00
4	22637854	PRESSER FOOT ASM.				1.00
5	22638050	PRESSER FOOT ASM.				1.00
6	22638258	PRESSER FOOT ASM.				1.00
7	22638357	PRESSER FOOT ASM.				1.00
8	22638456	PRESSER FOOT ASM.				1.00
9	22638753	PRESSER FOOT ASM.				1.00
10	22638951	PRESSER FOOT ASM.				1.00
11	22639157	PRESSER FOOT ASM.				1.00
12	22639256	PRESSER FOOT ASM.				1.00
13	22639355	PRESSER FOOT ASM.				1.00
14	22639454	PRESSER FOOT ASM.				1.00
15	40035896	PRESSER FOOT ASM.				1.00
16	40035897	PRESSER FOOT ASM.				1.00
17	22640353	PRESSER FOOT ASM.				1.00
18	22640452	PRESSER FOOT ASM.				1.00
19	22640551	PRESSER FOOT ASM.				1.00
20	22640759	PRESSER FOOT ASM.				1.00
21	22640858	PRESSER FOOT ASM.				1.00
22	22640957	PRESSER FOOT ASM.				1.00
23	22641054	PRESSER FOOT ASM.7/16(11.1MM)				1.00
24	22641252	PRESSER FOOT ASM.				1.00
25	22641351	PRESSER FOOT ASM.				1.00
26	22641450	PRESSER FOOT ASM.				1.00
27	22641658	PRESSER FOOT ASM.				1.00
28	22641757	PRESSER FOOT ASM.				1.00
29	22641856	PRESSER FOOT ASM.				1.00
30	22641955	PRESSER FOOT ASM.				1.00
31	22642052	PRESSER FOOT ASM.				1.00
32	22642151	PRESSER FOOT ASM.				1.00
33	40071909	PRESSER_FOOT_ASM_G_5/32				1.00
34	22816557	TIP-DIVIDED PRESSER ASM. 3/16				1.00
35	22816656	TIP-DIVIDED PRESSER ASM. 7/32				1.00
36	22816755	PRESSER FOOT ASM. 1/4				1.00
37	22816854	TIP-DIVIDED PRESSER ASM. 9/32				1.00
38	22816953	TIP-DIVIDED PRESSER ASM. 5/16				1.00
39	22817050	PRESSER FOOT ASM. D=2.4 (3/8)				1.00
40	40033941	TIP-DIVIDED_PRESSER_ASM_7/16				1.00
41	22817159	PRESSER FOOT ASM. D=2.4 (1/2)				1.00
42	40033945	TIP-DIVIDED_PRESSER_ASM_5/8				1.00
43	40033947	TIP-DIVIDED_PRESSER_ASM_3/4				1.00
44	40033949	TIP-DIVIDED_PRESSER_ASM_7/8				1.00
45	40033951	TIP-DIVIDED_PRESSER_ASM_1				1.00
46	40033953	TIP-DIVIDED_PRESSER_ASM_1_1/8				1.00
47	40033955	TIP-DIVIDED_PRESSER_ASM_1_1/4				1.00
48	40033957	TIP-DIVIDED_PRESSER_ASM_1_3/8				1.00
49	40033959	TIP-DIVIDED_PRESSER_ASM_1_1/2				1.00
50	10391852	PRESSER FOOT ASM. 1/8				1.00



51	10392058	PRESSER FOOT ASM. 3/16				1.00
52	10392256	PRESSER FOOT ASM. 1/4				1.00
53	10392751	PRESSER FOOT ASM. 1/2				1.00
54	10393056	PRESSER FOOT ASM. 3/4				1.00
55	22844450	COMPENSATING PRESSER ASM.(7/8)				1.00
56	22844559	BOBBIN CASE ASM, HEAVY FABLIC.				1.00
57	22627152	PRESSER FOOT F ASM. 1/8				1.00
58	22627350	F PRESSER FOOT ASM. 3/16				1.00
59	22627459	PRESSER FOOT ASM., 7/32				1.00
60	22627558	PRESSER FOOT F ASM. 1/4				1.00
61	22627657	PRESSER FOOT ASM., F 9/32				1.00
62	22627756	PRESSER FOOT ASM., F 5/16				1.00
63	22647051	SWIVEL GUIDE PRESSER 1/8 ASM.				1.00
64	22647150	GUIDE PRESSER ASM. 3/16				1.00
65	22647259	GUIDE PRESSER ASM. 7/32				1.00
66	22647358	GUIDE PRESSER ASM. 1/4				1.00
67	22647457	GUIDE PRESSER ASM. 9/32				1.00
68	22647556	SWIVEL GUIDE PRESSER 5/16 ASM				1.00
69	22601058	BED SLIDE LEFT, ASM., A				1.00
70	22601157	LEFT SLIDER PLATE B ASM.				1.00
71	22601256	BED SLIDE LEFT, ASM., C				1.00
72	22601355	BED SLIDE LEFT, ASM., C				1.00
73	22600555	BED SLIDE RIGHT, ASM., A				1.00
74	22600654	RIGHT SLIDER PLATE B ASM.				1.00
75	22600753	BED SLIDE RIGHT, ASM., C				1.00
76	22600852	BED SLIDE RIGHT, ASM., D				1.00
77	40042874	ASSY_SLIDE_PLATE_F_STANDARD				1.00
78	23206709	BED SLIDE (FRONT)A				1.00
79	40051633	ASSY_SLIDE_PLATE_L				1.00
80	40045729	ASSY_SIDE_PLATE-L-B				1.00
81	40045730	ASSY_SIDE_PLATE-L-C				1.00
82	40045731	ASSY_SIDE_PLATE-L-D				1.00







No.	品番	品名	備考	子部品	消耗品	個数
1	40033714	FEED_DOG_TYPE_AA_3/32				1.00
2	40033715	FEED_DOG_TYPE_AA_1/8				1.00
3	40033716	FEED_DOG_TYPE_AA_5/32				1.00
4	40033718	FEED_DOG_TYPE_AA_3/16				1.00
5	40033720	FEED_DOG_TYPE_AA_1/4				1.00
6	40033722	FEED_DOG_TYPE_AA_9/32				1.00
7	40033723	FEED_DOG_TYPE_AA_5/16				1.00
8	40033724	FEED_DOG_TYPE_AA_3/8				1.00
9	40033727	FEED_DOG_TYPE_AA_1/2				1.00
10	40033729	FEED_DOG_TYPE_AA_3/4				1.00
11	40033731	FEED_DOG_TYPE_AA_7/8				1.00
12	40033732	FEED_DOG_TYPE_AA_1				1.00
13	40033733	FEED_DOG_TYPE_AA_1_1/8				1.00
14	40033734	FEED_DOG_TYPE_AA_1_1/4				1.00
15	40035883	FEED_DOG_TYPE_F_1/8				1.00
16	40035884	FEED_DOG_TYPE_F_3/16				1.00
17	40035885	FEED_DOG_TYPE_F_7/32				1.00
18	40035886	FEED_DOG_TYPE_F_1/4				1.00
19	40035887	FEED_DOG_TYPE_F_9/32				1.00
20	40035888	FEED_DOG_TYPE_F_5/16				1.00
21	40033563	FEED_DOG_TYPE_F_1/8				1.00
22	40033564	FEED_DOG_TYPE_F_3/16				1.00
23	40033565	FEED_DOG_TYPE_F_7/32				1.00
24	40033566	FEED_DOG_TYPE_F_1/4				1.00
25	40033567	FEED_DOG_TYPE_F_9/32				1.00
26	40033568	FEED_DOG_TYPE_F_5/16				1.00
27	22630206	FEED DOG 5/32 (4.0MM)				1.00
28	22630404	FEED DOG 3/16 (4.8MM)				1.00
29	22630503	FEED DOG 7/32 (5.6MM)				1.00
30	22630602	FEED DOG 1/4				1.00
31	22630800	FEED DOG 9/32 (7.1MM)				1.00
32	22630909	FEED DOG 5/16 (7.9MM)				1.00
33	22631006	FEED DOG 3/8 (9.5MM)				1.00
34	22631105	FEED DOG 7/16 (11.1MM)				1.00
35	22631303	FEED DOG 1/2 (12.7MM)				1.00
36	22631402	FEED DOG 5/8 (15.9MM)				1.00
37	22631501	FEED DOG 3/4 (19.1MM)				1.00
38	22631709	FEED DOG 7/8 (2.2MM)				1.00
39	22631808	FEED DOG 1 (25.4MM)				1.00
40	22631907	FEED DOG 1.1/8 (28.6MM)				1.00
41	22632004	FEED DOG 1.1/4 (31.4MM)				1.00
42	22632103	FEED DOG 1.3/8 (34.9MM)				1.00
43	22632202	FEED DOG 1.1/2 (38.1MM)				1.00
44	40025784	FEED_DOG_TYPE_SA_5/32				1.00
45	40025785	FEED_DOG_TYPE_SA_3/16				1.00
46	40025786	FEED_DOG_TYPE_SA_7/32				1.00
47	40025787	FEED_DOG_TYPE_SA_1/4				1.00
48	40025788	FEED_DOG_TYPE_SA_9/32				1.00
49	40025789	FEED_DOG_TYPE_SA_5/16				1.00
50	40025790	FEED_DOG_TYPE_SA_3/8				1.00



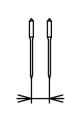
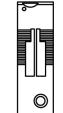
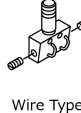
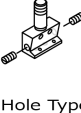

51	40025791	FEED_DOG_TYPE_SA_7/16				1.00
52	40025792	FEED_DOG_TYPE_SA_1/2				1.00
53	40025793	FEED_DOG_TYPE_SA_5/8				1.00
54	40025794	FEED_DOG_TYPE_SA_3/4				1.00
55	40025795	FEED_DOG_TYPE_SA_7/8				1.00
56	40025796	FEED_DOG_TYPE_SA_1				1.00
57	40025797	FEED_DOG_TYPE_SA_1-1/8				1.00
58	40025798	FEED_DOG_TYPE_SA_1-1/4				1.00
59	40025799	FEED_DOG_TYPE_SA_1-3/8				1.00
60	40025800	FEED_DOG_TYPE_SA_1-1/2				1.00
61	B1613512B0H	FEED DOG (1/8)				1.00
62	B1613512C0H	FEED DOG 5/32				1.00
63	B1613512D0H	FEED DOG 3/16				1.00
64	B1613512E0H	FEED DOG 7/32				1.00
65	B1613512F0H	FEED DOG 1/4				1.00
66	B1613512G0H	FEED DOG 9/32				1.00
67	B1613512H0H	FEED DOG 5/16				1.00
68	B1613512K0H	FEED DOG 3/8				1.00
69	40075311	FEED_DOG_TYPE_G_7/16				1.00
70	B1613512L0H	FEED DOG 1/2				1.00
71	B1613512M0H	FEED DOG 5/8				1.00
72	B1613512N0H	FEED DOG 3/4				1.00
73	B1613512P0H	FEED DOG 7/8				1.00
74	B1613512Q0H	FEED DOG 1				1.00
75	B1613512R0H	FEED DOG 1-1/8				1.00
76	B1613512S0H	FEED DOG 1-1/4				1.00
77	B1613512T0H	FEED DOG 1-3/8				1.00
78	B1613512U0H	FEED DOG 1-1/2				1.00
79	40025801	FEED_DOG_TYPE_G_3/16				1.00
80	40025802	FEED_DOG_TYPE_G_7/32				1.00
81	40025803	FEED_DOG_TYPE_G_1/4				1.00
82	40025804	FEED_DOG_TYPE_G_9/32				1.00
83	40025805	FEED_DOG_TYPE_G_5/16				1.00
84	40025806	FEED_DOG_TYPE_G_3/8				1.00
85	40025807	FEED_DOG_TYPE_G_7/16				1.00
86	40025808	FEED_DOG_TYPE_G_1/2				1.00
87	40025809	FEED_DOG_TYPE_G_5/8				1.00
88	40025810	FEED_DOG_TYPE_G_3/4				1.00
89	40025811	FEED_DOG_TYPE_G_7/8				1.00
90	40025812	FEED_DOG_TYPE_G_1				1.00
91	40025813	FEED_DOG_TYPE_G_1-1/8				1.00
92	40025814	FEED_DOG_TYPE_G_1-1/4				1.00
93	40025815	FEED_DOG_TYPE_G_1-3/8				1.00
94	40025816	FEED_DOG_TYPE_G_1-1/2				1.00
95	23205107	FEED DOG 1/8				1.00
96	23205305	FEED DOG 3/16				1.00
97	23205503	FEED DOG 1/4				1.00
98	40062249	FEED_DOG_1/2				1.00
99	40062251	FEED_DOG_3/4				1.00
100	40062252	FEED_DOG_7/8				1.00
101	40062253	FEED_DOG_1				1.00

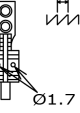
102	22848105	FEED DOG, (1/2).				1.00
103	22848303	FEED DOG, (3/4).				1.00
104	22848402	FEED DOG, (7/8).				1.00
105	22848501	FEED DOG, (1).				1.00
106	40035875	ASSY_NEEDLE_CLAMP(3/32)				1.00
107	40026027	ASSY_NEEDLE_CLAMP(1/8)				1.00
108	40026029	ASSY_NEEDLE_CLAMP(5/32)				1.00
109	40026031	ASSY_NEEDLE_CLAMP(3/16)				1.00
110	40026033	ASSY_NEEDLE_CLAMP(7/32)				1.00
111	40026035	ASSY_NEEDLE_CLAMP(1/4)				1.00
112	40026037	ASSY_NEEDLE_CLAMP(9/32)				1.00
113	40026039	ASSY_NEEDLE_CLAMP(5/16)				1.00
114	40026041	ASSY_NEEDLE_CLAMP(3/8)				1.00
115	40026043	ASSY_NEEDLE_CLAMP(7/16)				1.00
116	40026045	ASSY_NEEDLE_CLAMP(1/2)				1.00
117	40026047	ASSY_NEEDLE_CLAMP(5/8)				1.00
118	40026049	ASSY_NEEDLE_CLAMP(3/4)				1.00
119	40026051	ASSY_NEEDLE_CLAMP(7/8)				1.00
120	40026053	ASSY_NEEDLE_CLAMP(1)				1.00
121	40026055	ASSY_NEEDLE_CLAMP(1-1/8)				1.00
122	40026057	ASSY_NEEDLE_CLAMP(1-1/4)				1.00
123	40026059	ASSY_NEEDLE_CLAMP(1-3/8)				1.00
124	40026061	ASSY_NEEDLE_CLAMP(1-1/2)				1.00
125	10147551	NEEDLE CLAMP ASM. 3/32				1.00
126	10147650	NEEDLE CLAMP ASM. 1/8				1.00
127	10147759	NEEDLE CLAMP ASM. 5/32				1.00
128	10147858	NEEDLE CLAMP ASM. 3/16				1.00
129	10147957	NEEDLE CLAMP ASM. 7/32				1.00
130	10148054	NEEDLE CLAMP ASM. 1/4				1.00
131	10148153	NEEDLE CLAMP ASM. 9/32				1.00
132	10148252	NEEDLE CLAMP ASM. 5/16				1.00
133	10148351	NEEDLE CLAMP ASM. 3/8				1.00
134	10148450	NEEDLE CLAMP ASM. 7/16				1.00
135	10148559	NEEDLE CLAMP ASM. 1/2				1.00
136	10148658	NEEDLE CLAMP ASM. 5/8				1.00
137	10148757	NEEDLE CLAMP ASM. 3/4				1.00
138	10148856	NEEDLE CLAMP ASM. 7/8				1.00
139	10148955	NEEDLE CLAMP ASM. 1				1.00
140	10149052	NEEDLE CLAMP ASM. 1-1/8				1.00
141	10149151	NEEDLE CLAMP ASM. 1-1/4				1.00
142	10149250	NEEDLE CLAMP ASM. 1-3/8				1.00
143	10149359	NEEDLE CLAMP ASM. 1-1/2				1.00
144	22625008	THROAT PLATE 3/32 (2.4MM)				1.00
145	22625107	THROAT PLATE 1/8 (3.2MM)				1.00
146	40072337	THROAT_PLATE_G_1/8				1.00
147	22625206	THROAT PLATE 5/32 (4MM)				1.00
148	40072338	THROAT_PLATE_G_5/32				1.00
149	22625305	THROAT PLATE 3/16 (4.8MM)				1.00
150	22625404	THROAT PLATE 7/32 (5.6MM)				1.00
151	22625503	THROAT PLATE 1/4				1.00
152	22625602	THROAT PLATE 9/32 (7.1MM)				1.00

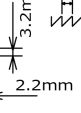
153	22625701	THROAT PLATE 5/16 (7.9MM)				1.00
154	22625800	THROAT PLATE 3/8 (9.5MM)				1.00
155	22625909	THROAT PLATE 7/16 (11.1MM)				1.00
156	22626006	THROAT PLATE 1/2 (12.7MM)				1.00
157	22626105	THROAT PLATE 5/8 (15.9MM)				1.00
158	22626204	THROAT PLATE 3/4 (19.1MM)				1.00
159	22626303	THROAT PLATE 7/8 (22.2MM)				1.00
160	22626402	THROAT PLATE 1 (25.4MM)				1.00
161	22626501	THROAT PLATE 1.1/8 (28.6MM)				1.00
162	22626600	THROAT PLATE 1.1/4 (31.8MM)				1.00
163	22626709	THROAT PLATE 1.3/8 (34.9MM)				1.00
164	22626808	THROAT PLATE 1.1/2 (38.1MM)				1.00
165	22628002	THROAT PLATE 1/8				1.00
166	22628101	THROAT PLATE 5/32				1.00
167	22628200	THROAT PLATE 3/16				1.00
168	22628309	THROAT PLATE, 7/32				1.00
169	22628408	THROAT PLATE 1/4				1.00
170	22628507	THROAT PLATE 9/32				1.00
171	22628606	TAPING THROAT PLATE 5/16				1.00
172	22845200	THROAT PLATE, (1/8).				1.00
173	22845408	THROAT PLATE, 3/16.				1.00
174	22845606	THROAT PLATE, (1/4).				1.00
175	40062254	THROAT_PLATE_1/2				1.00
176	40062256	THROAT_PLATE_3/4				1.00
177	40062257	THROAT_PLATE_7/8				1.00
178	40062258	THROAT_PLATE_1				1.00

# TABLE OF EXCHANGING GAUGE PARTS (FOR LH-3528-7)

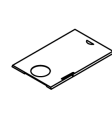
Needle gauge size 針 幅		Throat plate 針 板		Needle clamp asm. 針 留 組				Feed dog 送 り 歯								
Code コード					 Wire Type ワイヤタイプ		 Hole Type 穴タイプ		 1.7 1.9		 1.7 1.7 Option オプション		 1.7 2.4		 1.7 3.2mm 2.2mm Option オプション	
	inch	mm	No.	Part No.	No.	Part No.	No.	Part No.	No.	Part No.	No.	Part No.	No.	Part No.	No.	Part No.
A	3/32	2.4	—	—	(17)	400-35875	(36)	101-47551	—	—	—	—	—	—	—	—
B	1/8	3.2	(1)	400-35881	(18)	400-26027	(37)	101-47650	(55)	400-61270	(70)	400-35890	(86)	400-53705	(86)	400-53705
C	5/32	4.0	(2)	400-25485	(19)	400-26029	(38)	101-47759	(56)	400-61271	(71)	400-25817	(87)	400-71911	—	—
D	3/16	4.8	(3)	400-25490	(20)	400-26031	(39)	101-47858	(57)	400-61272	(72)	400-25818	(88)	400-35891	(101)	400-25831
E	7/32	5.6	(4)	400-25491	(21)	400-26033	(40)	101-47957	(58)	400-61273	(73)	400-25819	(89)	400-50009	(102)	400-25832
F	1/4	6.4	(5)	400-25492	(22)	400-26035	(41)	101-48054	(59)	400-61274	(74)	400-26715	(90)	400-35892	(103)	400-25833
G	9/32	7.1	(6)	400-25493	(23)	400-26037	(42)	101-48153	(60)	400-61275	(75)	400-25820	(91)	400-50010	(104)	400-25834
H	5/16	7.9	(7)	400-25494	(24)	400-26039	(43)	101-48252	(61)	400-61276	(76)	400-25821	(92)	400-50011	(105)	400-25835
K	3/8	9.5	(8)	400-25495	(25)	400-26041	(44)	101-48351	(62)	400-61277	(77)	400-25822	(93)	400-35893	(106)	400-25836
W	7/16	11.1	(9)	400-25496	(26)	400-26043	(45)	101-48450	—	—	(78)	400-25823	—	—	(107)	400-25837
L	1/2	12.7	(10)	400-25498	(27)	400-26045	(46)	101-48559	(63)	400-61278	(79)	400-25824	(94)	400-35894	(108)	400-25838
M	5/8	15.9	(11)	400-25499	(28)	400-26047	(47)	101-48658	(64)	400-61279	(80)	400-25825	(95)	400-71912	(109)	400-25839
N	3/4	19.1	(12)	400-25500	(29)	400-26049	(48)	101-48757	(65)	400-61280	(81)	400-25826	(96)	400-35895	(110)	400-25840
P	7/8	22.2	(13)	400-25502	(30)	400-26051	(49)	101-48856	(66)	400-61281	(82)	400-25827	(97)	400-71913	(111)	400-25841
Q	1	25.4	(14)	400-25503	(31)	400-26053	(50)	101-48955	(67)	400-61282	(83)	400-25828	(98)	400-71914	(112)	400-25842
R	1-1/8	28.6	(15)	400-25504	(32)	400-26055	(51)	101-49052	(68)	400-61283	(84)	400-25829	(99)	400-71915	(113)	400-25843
S	1-1/4	31.8	(16)	400-25505	(33)	400-26057	(52)	101-49151	(69)	400-61284	(85)	400-25830	(100)	400-71916	(114)	400-25844
T	1-3/8	34.9	—	—	(34)	400-26059	(53)	101-49250	—	—	—	—	—	—	—	—
U	1-1/2	38.1	—	—	(35)	400-26061	(54)	101-49359	—	—	—	—	—	—	—	—
Stitch spec. 縫 仕 様	A						★									
	F						★									
	S			★		★			★		★					
	G			★			★						★			★

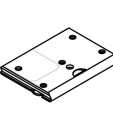
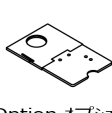
Needle gauge size 針 幅		Presser foot asm. 押 さ え(組)				Sliding plate asm. (Left) 滑 り 板(左)組		Sliding plate asm. (Right) 滑 り 板(右)組		Sliding plate asm. (Front) 滑 り 板(前)組		Sliding plate asm. (Left) 滑 り 板(左)組		
Code コード			 (Tip-divided) 移動式先割れ 2.0mm		 (Tip-divided) 移動式先割れ 2.4mm								 Option オプション	
	inch	mm	No.	Part No.	No.	Part No.	No.	Part No.	No.	Part No.	No.	Part No.	No.	Part No.
B	1/8	3.2	(115)	400-35896	(115)	400-35896								
C	5/32	4.0	(116)	400-35897	(131)	400-71909								
D	3/16	4.8	(117)	226-40353	(132)	228-16557								
E	7/32	5.6	(118)	226-40452	(133)	228-16656								
F	1/4	6.4	(119)	226-40551	(134)	228-16755	(146)	400-25247	(150)	400-25235			(155)	400-51633
G	9/32	7.1	(120)	226-40759	(135)	228-16854								
H	5/16	7.9	(121)	226-40858	(136)	228-16953								
K	3/8	9.5	(122)	226-40957	(137)	228-17050					(154)	400-42880		
W	7/16	11.1	(123)	226-41054	(138)	400-33941								
L	1/2	12.7	(124)	226-41252	(139)	228-17159								
M	5/8	15.9	(125)	226-41351	(140)	400-33945	(147)	400-25248	(151)	400-25236			(156)	400-45729
N	3/4	19.1	(126)	226-41450	(141)	400-33947								
P	7/8	22.2	(127)	226-41658	(142)	400-33949								
Q	1	25.4	(128)	226-41757	(143)	400-33951	(148)	400-25249	(152)	400-25239			(157)	400-45730
R	1-1/8	28.6	(129)	226-41856	(144)	400-33953								
S	1-1/4	31.8	(130)	226-41955	(145)	400-33955	(149)	400-25250	(153)	400-25240			(158)	400-45731
Stitch spec. 縫 仕 様	S			★			Spec.common		Spec.common		Spec.common		Spec.common	
	G				★		仕様 共通		仕様 共通		仕様 共通		仕様 共通	

No.	品番	品名	備考	子部品	消耗品	個数
1	40035881	THROAT_PLATE_TRIM_1/8				1.00
2	40025485	THROAT_PLATE_TRIM 5/32				1.00
3	40025490	THROAT_PLATE_TRIM-3/16				1.00
4	40025491	THROAT_PLATE_TRIM-7/32				1.00
5	40025492	THROAT_PLATE_TRIM-1/4				1.00
6	40025493	THROAT_PLATE_TRIM-9/32				1.00
7	40025494	THROAT_PLATE_TRIM-5/16				1.00
8	40025495	THROAT_PLATE_TRIM-3/8				1.00
9	40025496	THROAT_PLATE_TRIM-7/16				1.00
10	40025498	THROAT_PLATE_TRIM-1/2				1.00
11	40025499	THROAT_PLATE_TRIM-5/8				1.00
12	40025500	THROAT_PLATE_TRIM-3/4				1.00
13	40025502	THROAT_PLATE_TRIM-7/8				1.00
14	40025503	THROAT_PLATE_TRIM-1				1.00
15	40025504	THROAT_PLATE_TRIM-1-1/8				1.00
16	40025505	THROAT_PLATE_TRIM-1-1/4				1.00
17	40035875	ASSY_NEEDLE_CLAMP(3/32)				1.00
18	40026027	ASSY_NEEDLE_CLAMP(1/8)				1.00
19	40026029	ASSY_NEEDLE_CLAMP(5/32)				1.00
20	40026031	ASSY_NEEDLE_CLAMP(3/16)				1.00
21	40026033	ASSY_NEEDLE_CLAMP(7/32)				1.00
22	40026035	ASSY_NEEDLE_CLAMP(1/4)				1.00
23	40026037	ASSY_NEEDLE_CLAMP(9/32)				1.00
24	40026039	ASSY_NEEDLE_CLAMP(5/16)				1.00
25	40026041	ASSY_NEEDLE_CLAMP(3/8)				1.00
26	40026043	ASSY_NEEDLE_CLAMP(7/16)				1.00
27	40026045	ASSY_NEEDLE_CLAMP(1/2)				1.00
28	40026047	ASSY_NEEDLE_CLAMP(5/8)				1.00
29	40026049	ASSY_NEEDLE_CLAMP(3/4)				1.00
30	40026051	ASSY_NEEDLE_CLAMP(7/8)				1.00
31	40026053	ASSY_NEEDLE_CLAMP(1)				1.00
32	40026055	ASSY_NEEDLE_CLAMP(1-1/8)				1.00
33	40026057	ASSY_NEEDLE_CLAMP(1-1/4)				1.00
34	40026059	ASSY_NEEDLE_CLAMP(1-3/8)				1.00
35	40026061	ASSY_NEEDLE_CLAMP(1-1/2)				1.00
36	10147551	NEEDLE CLAMP ASM. 3/32				1.00
37	10147650	NEEDLE CLAMP ASM. 1/8				1.00
38	10147759	NEEDLE CLAMP ASM. 5/32				1.00
39	10147858	NEEDLE CLAMP ASM. 3/16				1.00
40	10147957	NEEDLE CLAMP ASM. 7/32				1.00
41	10148054	NEEDLE CLAMP ASM. 1/4				1.00
42	10148153	NEEDLE CLAMP ASM. 9/32				1.00
43	10148252	NEEDLE CLAMP ASM. 5/16				1.00
44	10148351	NEEDLE CLAMP ASM. 3/8				1.00
45	10148450	NEEDLE CLAMP ASM. 7/16				1.00
46	10148559	NEEDLE CLAMP ASM. 1/2				1.00
47	10148658	NEEDLE CLAMP ASM. 5/8				1.00
48	10148757	NEEDLE CLAMP ASM. 3/4				1.00
49	10148856	NEEDLE CLAMP ASM. 7/8				1.00
50	10148955	NEEDLE CLAMP ASM. 1				1.00



51	10149052	NEEDLE CLAMP ASM. 1-1/8				1.00
52	10149151	NEEDLE CLAMP ASM. 1-1/4				1.00
53	10149250	NEEDLE CLAMP ASM. 1-3/8				1.00
54	10149359	NEEDLE CLAMP ASM. 1-1/2				1.00
55	40061270	FEED_DOG_TYPE-S 1/8				1.00
56	40061271	FEED_DOG_TYPE-S 5/32				1.00
57	40061272	FEED_DOG_TYPE-S 3/16				1.00
58	40061273	FEED_DOG_TYPE-S 7/32				1.00
59	40061274	FEED_DOG_TYPE-S 1/4				1.00
60	40061275	FEED_DOG_TYPE-S 9/32				1.00
61	40061276	FEED_DOG_TYPE-S 5/16				1.00
62	40061277	FEED_DOG_TYPE-S 3/8				1.00
63	40061278	FEED_DOG_TYPE-S 1/2				1.00
64	40061279	FEED_DOG_TYPE-S 5/8				1.00
65	40061280	FEED_DOG_TYPE-S 3/4				1.00
66	40061281	FEED_DOG_TYPE-S 7/8				1.00
67	40061282	FEED_DOG_TYPE-S 1				1.00
68	40061283	FEED_DOG_TYPE-S 1 1/8				1.00
69	40061284	FEED_DOG_TYPE-S 1 1/4				1.00
70	40035890	FEED_DOG_TYPE-S 1/8				1.00
71	40025817	FEED_DOG_TYPE-S 5/32				1.00
72	40025818	FEED_DOG_TYPE-S 3/16				1.00
73	40025819	FEED_DOG_TYPE-S 7/32				1.00
74	40026715	FEED_DOG_TYPE-S 1/4				1.00
75	40025820	FEED_DOG_TYPE-S 9/32				1.00
76	40025821	FEED_DOG_TYPE-S 5/16				1.00
77	40025822	FEED_DOG_TYPE-S 3/8				1.00
78	40025823	FEED_DOG_TYPE-S 7/16				1.00
79	40025824	FEED_DOG_TYPE-S 1/2				1.00
80	40025825	FEED_DOG_TYPE-S 5/8				1.00
81	40025826	FEED_DOG_TYPE-S 3/4				1.00
82	40025827	FEED_DOG_TYPE-S 7/8				1.00
83	40025828	FEED_DOG_TYPE-S 1				1.00
84	40025829	FEED_DOG_TYPE-S 1 1/8				1.00
85	40025830	FEED_DOG_TYPE-S 1 1/4				1.00
86	40053705	FEED_DOG_TYPE_7G_1/8				1.00
87	40071911	FEED_DOG_7G_5/32				1.00
88	40035891	FEED_DOG_TYPE_7G_3/16				1.00
89	40050009	FEED_DOG_TYPE_7G_7/32				1.00
90	40035892	FEED_DOG_TYPE_7G_1/4				1.00
91	40050010	FEED_DOG_TYPE_7G_9/32				1.00
92	40050011	FEED_DOG_TYPE_7G_5/16				1.00
93	40035893	FEED_DOG_TYPE_7G_3/8				1.00
94	40035894	FEED_DOG_TYPE_7G_1/2				1.00
95	40071912	FEED_DOG_7G_5/8				1.00
96	40035895	FEED_DOG_TYPE_7G_3/4				1.00
97	40071913	FEED_DOG_7G_7/8				1.00
98	40071914	FEED_DOG_7G_1				1.00
99	40071915	FEED_DOG_7G_1-1/8				1.00
100	40071916	FEED_DOG_7G_1-1/4				1.00
101	40025831	FEED_DOG_TYPE_7G_3/16				1.00

102	40025832	FEED_DOG_TYPE_7G_7/32				1.00
103	40025833	FEED_DOG_TYPE_7G_1/4				1.00
104	40025834	FEED_DOG_TYPE_7G_9/32				1.00
105	40025835	FEED_DOG_TYPE_7G_5/16				1.00
106	40025836	FEED_DOG_TYPE_7G_3/8				1.00
107	40025837	FEED_DOG_TYPE_7G_7/16				1.00
108	40025838	FEED_DOG_TYPE_7G_1/2				1.00
109	40025839	FEED_DOG_TYPE_7G_5/8				1.00
110	40025840	FEED_DOG_TYPE_7G_3/4				1.00
111	40025841	FEED_DOG_TYPE_7G_7/8				1.00
112	40025842	FEED_DOG_TYPE_7G_1				1.00
113	40025843	FEED_DOG_TYPE_7G_1-1/8				1.00
114	40025844	FEED_DOG_TYPE_7G_1-1/4				1.00
115	40035896	PRESSER FOOT ASM.				1.00
116	40035897	PRESSER FOOT ASM.				1.00
117	22640353	PRESSER FOOT ASM.				1.00
118	22640452	PRESSER FOOT ASM.				1.00
119	22640551	PRESSER FOOT ASM.				1.00
120	22640759	PRESSER FOOT ASM.				1.00
121	22640858	PRESSER FOOT ASM.				1.00
122	22640957	PRESSER FOOT ASM.				1.00
123	22641054	PRESSER FOOT ASM.7/16(11.1MM)				1.00
124	22641252	PRESSER FOOT ASM.				1.00
125	22641351	PRESSER FOOT ASM.				1.00
126	22641450	PRESSER FOOT ASM.				1.00
127	22641658	PRESSER FOOT ASM.				1.00
128	22641757	PRESSER FOOT ASM.				1.00
129	22641856	PRESSER FOOT ASM.				1.00
130	22641955	PRESSER FOOT ASM.				1.00
131	40071909	PRESSER_FOOT_ASM_G_5/32				1.00
132	22816557	TIP-DIVIDED PRESSER ASM. 3/16				1.00
133	22816656	TIP-DIVIDED PRESSER ASM. 7/32				1.00
134	22816755	PRESSER FOOT ASM. 1/4				1.00
135	22816854	TIP-DIVIDED PRESSER ASM. 9/32				1.00
136	22816953	TIP-DIVIDED PRESSER ASM. 5/16				1.00
137	22817050	PRESSER FOOT ASM. D=2.4 (3/8)				1.00
138	40033941	TIP-DIVIDED_PRESSER_ASM_7/16				1.00
139	22817159	PRESSER FOOT ASM. D=2.4 (1/2)				1.00
140	40033945	TIP-DIVIDED_PRESSER_ASM_5/8				1.00
141	40033947	TIP-DIVIDED_PRESSER_ASM_3/4				1.00
142	40033949	TIP-DIVIDED_PRESSER_ASM_7/8				1.00
143	40033951	TIP-DIVIDED_PRESSER_ASM_1				1.00
144	40033953	TIP-DIVIDED_PRESSER_ASM_1_1/8				1.00
145	40033955	TIP-DIVIDED_PRESSER_ASM_1_1/4				1.00
146	40025247	ASSY_SLIDE_PLATE-L-A				1.00
147	40025248	ASSY_SLIDE_PLATE-L-B				1.00
148	40025249	ASSY_SLIDE_PLATE-L-C				1.00
149	40025250	ASSY_SLIDE_PLATE-L-D				1.00
150	40025235	ASSY_SLIDE_PLATE-R-A				1.00
151	40025236	ASSY_SLIDE_PLATE-R-B				1.00
152	40025239	ASSY_SLIDE_PLATE-R-C				1.00

153	40025240	ASSY_SLIDE_PLATE-R-D				1.00
154	40042880	ASSY_SLIDE_PLATE_F				1.00
155	40051633	ASSY_SLIDE_PLATE_L				1.00
156	40045729	ASSY_SIDE_PLATE-L-B				1.00
157	40045730	ASSY_SIDE_PLATE-L-C				1.00
158	40045731	ASSY_SIDE_PLATE-L-D				1.00



No.	品番	品名	備考	子部品	消耗品	個数
1	40035761	ASSY_NEEDLE_CLAMP_L(1/8)				1.00
2	40035762	ASSY_NEEDLE_CLAMP_L(5/32)				1.00
3	40035763	ASSY_NEEDLE_CLAMP_L(3/16)				1.00
4	40035764	ASSY_NEEDLE_CLAMP_L(7/32)				1.00
5	40029561	ASSY_NEEDLE_CLAMP_L(1/4)				1.00
6	40035765	ASSY_NEEDLE_CLAMP_L(9/32)				1.00
7	40035766	ASSY_NEEDLE_CLAMP_L(5/16)				1.00
8	40035767	ASSY_NEEDLE_CLAMP_L(3/8)				1.00
9	40035768	ASSY_NEEDLE_CLAMP_L(1/2)				1.00
10	40035769	ASSY_NEEDLE_CLAMP_L(5/8)				1.00
11	40035770	ASSY_NEEDLE_CLAMP_L(3/4)				1.00
12	40071917	ASSY_NEEDLE_CLAMP_L_7/8				1.00
13	40071921	ASSY_NEEDLE_CLAMP_L_1				1.00
14	40035771	ASSY_NEEDLE_CLAMP_R(1/8)				1.00
15	40035772	ASSY_NEEDLE_CLAMP_R(5/32)				1.00
16	40035773	ASSY_NEEDLE_CLAMP_R(3/16)				1.00
17	40035774	ASSY_NEEDLE_CLAMP_R(7/32)				1.00
18	40029562	ASSY_NEEDLE_CLAMP_R(1/4)				1.00
19	40035775	ASSY_NEEDLE_CLAMP_R(9/32)				1.00
20	40035776	ASSY_NEEDLE_CLAMP_R(5/16)				1.00
21	40035777	ASSY_NEEDLE_CLAMP_R(3/8)				1.00
22	40035778	ASSY_NEEDLE_CLAMP_R(1/2)				1.00
23	40035779	ASSY_NEEDLE_CLAMP_R(5/8)				1.00
24	40035780	ASSY_NEEDLE_CLAMP_R(3/4)				1.00
25	40071919	ASSY_NEEDLE_CLAMP_R_7/8				1.00
26	40071923	ASSY_NEEDLE_CLAMP_R_1				1.00
27	B1402528BA0A	NEEDLE CLAMP ASM. 1/8				1.00
28	B1402528CA0A	NEEDLE CLAMP ASM. 5/32				1.00
29	B1402528DALA	NEEDLE CLAMP ASM. LEFT				1.00
30	B1402528EAL	NEEDLE CLAMP ASM. 7/32				1.00
31	B1402528FALA	NEEDLE CLAMP ASM. 1/4				1.00
32	B1402528GAL	NEEDLE CLAMP ASM., LEFT				1.00
33	B1402528HALA	NEEDLE CLAMP ASM. 5/16				1.00
34	B1402528KALA	NEEDLE CLAMP ASM. 3/8				1.00
35	B1402528LAL	NEEDLE CLAMP ASM., LEFT 1/2				1.00
36	B1402528MAL	NEEDLE CLAMP ASM., LEFT 5/8				1.00
37	B1402528NAL	NEEDLE CLAMP ASM., LEFT 3/4				1.00
38	B1402528PAL	NEEDLE CLAMP ASM. LEFT 7/8				1.00
39	B1402528QAL	NEEDLE CLAMP ASM., LEFT 1				1.00
40	B1402528DARA	NEEDLE CLAMP ASM. RIGHT				1.00
41	B1402528EAR	NEEDLE CLAMP ASM. 7/32				1.00
42	B1402528FARA	NEEDLE CLAMP ASM. 1/4				1.00
43	B1402528GAR	NEEDLE CLAMP ASM., RIGHT				1.00
44	B1402528HARA	NEEDLE CLAMP ASM. 5/16				1.00
45	B1402528KARA	NEEDLE CLAMP ASM. 3/8				1.00
46	B1402528LAR	NEEDLE CLAMP ASM., RIGHT 1/2				1.00
47	B1402528MAR	NEEDLE CLAMP ASM., RIGHT 5/8				1.00
48	B1402528NAR	NEEDLE CLAMP ASM., RIGHT 3/4				1.00
49	B1402528PAR	NEEDLE CLAMP ASM. RIGHT 7/8				1.00
50	B1402528QAR	NEEDLE CLAMP ASM., RIGHT 1				1.00









51	40042874	ASSY_SLIDE_PLATE_F_STANDARD				1.00
52	40051633	ASSY_SLIDE_PLATE_L				1.00
53	40045729	ASSY_SIDE_PLATE-L-B				1.00
54	40045730	ASSY_SIDE_PLATE-L-C				1.00
55	40035877	ASSY_NEEDLE_CLAMP_L(1/8)				1.00
56	40026063	ASSY_NEEDLE_CLAMP_L(5/32)				1.00
57	40026065	ASSY_NEEDLE_CLAMP_L(3/16)				1.00
58	40026067	ASSY_NEEDLE_CLAMP_L(7/32)				1.00
59	40026069	ASSY_NEEDLE_CLAMP_L(1/4)				1.00
60	40026070	ASSY_NEEDLE_CLAMP_L(9/32)				1.00
61	40026072	ASSY_NEEDLE_CLAMP_L(5/16)				1.00
62	40026074	ASSY_NEEDLE_CLAMP_L(3/8)				1.00
63	40026076	ASSY_NEEDLE_CLAMP_L(1/2)				1.00
64	40026078	ASSY_NEEDLE_CLAMP_L(5/8)				1.00
65	40026080	ASSY_NEEDLE_CLAMP_L(3/4)				1.00
66	40026082	ASSY_NEEDLE_CLAMP_L(1)				1.00
67	40035878	ASSY_NEEDLE_CLAMP_R(1/8)				1.00
68	40026084	ASSY_NEEDLE_CLAMP_R(5/32)				1.00
69	40026086	ASSY_NEEDLE_CLAMP_R(3/16)				1.00
70	40026088	ASSY_NEEDLE_CLAMP_R(7/32)				1.00
71	40026090	ASSY_NEEDLE_CLAMP_R(1/4)				1.00
72	40026091	ASSY_NEEDLE_CLAMP_R(9/32)				1.00
73	40026093	ASSY_NEEDLE_CLAMP_R(5/16)				1.00
74	40026095	ASSY_NEEDLE_CLAMP_R(3/8)				1.00
75	40026097	ASSY_NEEDLE_CLAMP_R(1/2)				1.00
76	40026099	ASSY_NEEDLE_CLAMP_R(5/8)				1.00
77	40026101	ASSY_NEEDLE_CLAMP_R(3/4)				1.00
78	40026103	ASSY_NEEDLE_CLAMP_R(1)				1.00
79	B1402526BA0A	NEEDLE CLAMP ASM. 1/8				1.00
80	B1402526CA0A	NEEDLE CLAMP ASM. 5/32				1.00
81	B1402526DALA	NEEDLE CLAMP LEFT ASM. 3/16				1.00
82	10228559	NEEDLE CLAMP ASM. LEFT 7/32				1.00
83	B1402526FALA	NEEDLE CLAMP LEFT ASM. 1/4				1.00
84	B1402526GALA	NEEDLE CLAMP LEFT ASM. 9/32				1.00
85	B1402526HALA	NEEDLE CLAMP LEFT ASM. 5/16				1.00
86	B1402526KALA	NEEDLE CLAMP LEFT ASM. 3/8				1.00
87	B1402526LALA	NEEDLE CLAMP LEFT ASM.				1.00
88	10228856	NEEDLE CLAMP ASM. LEFT 5/8				1.00
89	10228955	NEEDLE CLAMP ASM. LEFT 3/4				1.00
90	10229151	NEEDLE CLAMP ASM. LEFT 1				1.00
91	B1402526DARA	NEEDLE CLAMP RIGHT ASM. 3/16				1.00
92	10228567	NEEDLE CLAMP ASM. RIGHT 7/32				1.00
93	B1402526FARA	NEEDLE CLAMP RIGHT ASM. 1/4				1.00
94	B1402526GARA	NEEDLE CLAMP RIGHT ASM. 9/32				1.00
95	B1402526HARA	NEEDLE CLAMP RIGHT ASM. 5/16				1.00
96	B1402526KARA	NEEDLE CLAMP RIGHT ASM. 3/8				1.00
97	B1402526LARA	NEEDLE CLAMP RIGHT ASM.				1.00
98	10228864	NEEDLE CLAMP ASM. RIGHT 5/8				1.00
99	10228963	NEEDLE CLAMP ASM. RIGHT 3/4				1.00
100	10229169	NEEDLE CLAMP ASM. RIGHT 1				1.00
101	22601058	BED SLIDE LEFT, ASM., A				1.00







102	22601157	LEFT SLIDER PLATE B ASM.				1.00
103	22601256	BED SLIDE LEFT, ASM., C				1.00
104	22600555	BED SLIDE RIGHT, ASM., A				1.00
105	22600654	RIGHT SLIDER PLATE B ASM.				1.00
106	22600753	BED SLIDE RIGHT, ASM., C				1.00
107	22625107	THROAT PLATE 1/8 (3.2MM)				1.00
108	22625206	THROAT PLATE 5/32 (4MM)				1.00
109	40072338	THROAT_PLATE_G_5/32				1.00
110	22625305	THROAT PLATE 3/16 (4.8MM)				1.00
111	22625404	THROAT PLATE 7/32 (5.6MM)				1.00
112	22625503	THROAT PLATE 1/4				1.00
113	22625602	THROAT PLATE 9/32 (7.1MM)				1.00
114	22625701	THROAT PLATE 5/16 (7.9MM)				1.00
115	22625800	THROAT PLATE 3/8 (9.5MM)				1.00
116	22626006	THROAT PLATE 1/2 (12.7MM)				1.00
117	22626105	THROAT PLATE 5/8 (15.9MM)				1.00
118	22626204	THROAT PLATE 3/4 (19.1MM)				1.00
119	22626303	THROAT PLATE 7/8 (22.2MM)				1.00
120	22626402	THROAT PLATE 1 (25.4MM)				1.00
121	22630206	FEED DOG 5/32 (4.0MM)				1.00
122	22630404	FEED DOG 3/16 (4.8MM)				1.00
123	22630503	FEED DOG 7/32 (5.6MM)				1.00
124	22630602	FEED DOG 1/4				1.00
125	22630800	FEED DOG 9/32 (7.1MM)				1.00
126	22630909	FEED DOG 5/16 (7.9MM)				1.00
127	22631006	FEED DOG 3/8 (9.5MM)				1.00
128	22631303	FEED DOG 1/2 (12.7MM)				1.00
129	22631402	FEED DOG 5/8 (15.9MM)				1.00
130	22631501	FEED DOG 3/4 (19.1MM)				1.00
131	22631709	FEED DOG 7/8 (2.2MM)				1.00
132	22631808	FEED DOG 1 (25.4MM)				1.00
133	40033563	FEED_DOG_TYPE_F_1/8				1.00
134	40025784	FEED_DOG_TYPE_SA_5/32				1.00
135	40025785	FEED_DOG_TYPE_SA_3/16				1.00
136	40025786	FEED_DOG_TYPE_SA_7/32				1.00
137	40025787	FEED_DOG_TYPE_SA_1/4				1.00
138	40025788	FEED_DOG_TYPE_SA_9/32				1.00
139	40025789	FEED_DOG_TYPE_SA_5/16				1.00
140	40025790	FEED_DOG_TYPE_SA_3/8				1.00
141	40025792	FEED_DOG_TYPE_SA_1/2				1.00
142	40025793	FEED_DOG_TYPE_SA_5/8				1.00
143	40025794	FEED_DOG_TYPE_SA_3/4				1.00
144	40025795	FEED_DOG_TYPE_SA_7/8				1.00
145	40025796	FEED_DOG_TYPE_SA_1				1.00
146	B1613512C0H	FEED DOG 5/32				1.00
147	B1613512D0H	FEED DOG 3/16				1.00
148	B1613512E0H	FEED DOG 7/32				1.00
149	B1613512F0H	FEED DOG 1/4				1.00
150	B1613512G0H	FEED DOG 9/32				1.00
151	B1613512H0H	FEED DOG 5/16				1.00
152	B1613512K0H	FEED DOG 3/8				1.00







153	B1613512L0H	FEED DOG 1/2				1.00
154	B1613512M0H	FEED DOG 5/8				1.00
155	B1613512N0H	FEED DOG 3/4				1.00
156	B1613512P0H	FEED DOG 7/8				1.00
157	B1613512Q0H	FEED DOG 1				1.00
158	40025801	FEED_DOG_TYPE_G_3/16				1.00
159	40025802	FEED_DOG_TYPE_G_7/32				1.00
160	40025803	FEED_DOG_TYPE_G_1/4				1.00
161	40025804	FEED_DOG_TYPE_G_9/32				1.00
162	40025805	FEED_DOG_TYPE_G_5/16				1.00
163	40025806	FEED_DOG_TYPE_G_3/8				1.00
164	40025808	FEED_DOG_TYPE_G_1/2				1.00
165	40025809	FEED_DOG_TYPE_G_5/8				1.00
166	40025810	FEED_DOG_TYPE_G_3/4				1.00
167	40025811	FEED_DOG_TYPE_G_7/8				1.00
168	40025812	FEED_DOG_TYPE_G_1				1.00
169	40035896	PRESSER FOOT ASM.				1.00
170	40035897	PRESSER FOOT ASM.				1.00
171	22640353	PRESSER FOOT ASM.				1.00
172	22640452	PRESSER FOOT ASM.				1.00
173	22640551	PRESSER FOOT ASM.				1.00
174	22640759	PRESSER FOOT ASM.				1.00
175	22640858	PRESSER FOOT ASM.				1.00
176	22640957	PRESSER FOOT ASM.				1.00
177	22641252	PRESSER FOOT ASM.				1.00
178	22641351	PRESSER FOOT ASM.				1.00
179	22641450	PRESSER FOOT ASM.				1.00
180	22641658	PRESSER FOOT ASM.				1.00
181	22641757	PRESSER FOOT ASM.				1.00
182	40071909	PRESSER_FOOT_ASM_G_5/32				1.00
183	22816557	TIP-DIVIDED PRESSER ASM. 3/16				1.00
184	22816656	TIP-DIVIDED PRESSER ASM. 7/32				1.00
185	22816755	PRESSER FOOT ASM. 1/4				1.00
186	22816854	TIP-DIVIDED PRESSER ASM. 9/32				1.00
187	22816953	TIP-DIVIDED PRESSER ASM. 5/16				1.00
188	22817050	PRESSER FOOT ASM. D=2.4 (3/8)				1.00
189	22817159	PRESSER FOOT ASM. D=2.4 (1/2)				1.00
190	40033945	TIP-DIVIDED_PRESSER_ASM_5/8				1.00
191	40033947	TIP-DIVIDED_PRESSER_ASM_3/4				1.00
192	40033949	TIP-DIVIDED_PRESSER_ASM_7/8				1.00
193	40033951	TIP-DIVIDED_PRESSER_ASM_1				1.00



# TABLE OF EXCHANGING GAUGE PARTS (FOR LH-3568-7)

Needle gauge size 針 幅			Feed Dog 送り 歯								Presser foot asm. 押 さ え(組)				Throat plate 針 板	
Code コード					Option オプション 				Option オプション 		(Tip-divided) (移動式先割れ) 		(Tip-divided) (移動式先割れ) 			
	inch	mm	No.	Part No.	No.	Part No.	No.	Part No.	No.	Part No.	No.	Part No.	No.	Part No.	No.	Part No.
B	1/8	3.2	①	400-61270	⑭	400-35890	⑳	400-53705	④⑩	400-53705	⑤⑪	400-35896	⑤⑪	400-35896	⑦⑬	400-35881
C	5/32	4.0	②	400-61271	⑮	400-25817	㉑	400-71911	—	—	⑤⑫	400-35897	⑥⑫	400-71909	⑧⑭	400-25485
D	3/16	4.8	③	400-61272	⑯	400-25818	㉒	400-35891	④⑪	400-25831	⑤⑬	226-40353	⑥⑬	228-16557	⑨⑮	400-25490
E	7/32	5.6	④	400-61273	⑰	400-25819	㉓	400-50009	④⑫	400-25832	⑤⑭	226-40452	⑥⑭	228-16656	⑩⑯	400-25491
F	1/4	6.4	⑤	400-61274	⑱	400-26715	㉔	400-35892	④⑬	400-25833	⑤⑮	226-40551	⑥⑮	228-16755	⑪⑰	400-25492
G	9/32	7.1	⑥	400-61275	⑲	400-25820	㉕	400-50010	④⑭	400-25834	⑤⑯	226-40759	⑥⑯	228-16854	⑫⑱	400-25493
H	5/16	7.9	⑦	400-61276	⑳	400-25821	㉖	400-50011	④⑮	400-25835	⑤⑰	226-40858	⑥⑰	228-16953	⑬⑲	400-25494
K	3/8	9.5	⑧	400-61277	㉑	400-61277	㉗	400-35893	④⑯	400-25836	⑤⑱	226-40957	⑥⑱	228-17050	⑭⑲	400-25495
L	1/2	12.7	⑨	400-61278	㉒	400-25824	㉘	400-35894	④⑰	400-25838	⑤⑲	226-41252	⑥⑲	228-17159	⑮⑲	400-25498
M	5/8	15.9	⑩	400-61279	㉓	400-25825	㉙	400-71912	④⑱	400-25839	⑤⑲	226-41351	⑥⑲	400-33945	⑯⑲	400-25499
N	3/4	19.1	⑪	400-61280	㉔	400-25826	㉚	400-35895	④⑲	400-25840	⑤⑲	226-41450	⑥⑲	400-33947	⑰⑲	400-25500
P	7/8	22.2	⑫	400-61281	㉕	400-61281	㉛	400-71913	④⑲	400-25841	⑤⑲	226-41658	⑥⑲	400-33949	⑱⑲	400-25502
Q	1	25.4	⑬	400-61282	㉖	400-25828	㉜	400-71914	⑤⑲	400-25842	⑥⑲	226-41757	⑥⑲	400-33951	⑲⑲	400-25503
Stitch spec. 縫 仕 様	S	★		★		★		★		★		★		★		Spec.common
	G															仕 様 共 通

Needle gauge size 針 幅			Needle clamp asm.(for DP 5) 針 留 組 (D P 5 用)								Sliding plate asm. (Front) 滑り板(前)組		Sliding plate asm. (Left) 滑り板(左)組	
Code コード			Needle clamp asm. (Left) 針 留(左)組 		Needle clamp asm. (Right) 針 留(右)組 		Needle clamp asm. (Left) 針 留(左)組 		Needle clamp asm. (Right) 針 留(右)組 					
	inch	mm	No.	Part No.	No.	Part No.	No.	Part No.	No.	Part No.	No.	Part No.	No.	Part No.
B	1/8	3.2	⑩	400-35761	⑩③	400-35771	⑩⑥	B1402-528-BA0-A	⑩⑥	B1402-528-BA0-A	⑭④	400-42880	⑭①	400-51633
C	5/32	4.0	⑪	400-35762	⑩④	400-35772	⑩⑦	B1402-528-CA0-A	⑩⑦	B1402-528-CA0-A				
D	3/16	4.8	⑫	400-35763	⑩⑤	400-35773	⑩⑧	B1402-528-DAL-A	⑩⑧	B1402-528-DAR-A				
E	7/32	5.6	⑬	400-35764	⑩⑥	400-35774	⑩⑨	B1402-528-EAL	⑩⑨	B1402-528-EAR				
F	1/4	6.4	⑭	400-29561	⑩⑦	400-29562	⑩⑩	B1402-528-FAL-A	⑩⑩	B1402-528-FAR-A				
G	9/32	7.1	⑮	400-35765	⑩⑧	400-35775	⑩⑪	B1402-528-GAL	⑩⑪	B1402-528-GAR				
H	5/16	7.9	⑯	400-35766	⑩⑨	400-35776	⑩⑫	B1402-528-HAL-A	⑩⑫	B1402-528-HAR-A				
K	3/8	9.5	⑰	400-35767	⑩⑩	400-35777	⑩⑬	B1402-528-KAL-A	⑩⑬	B1402-528-KAR-A				
L	1/2	12.7	⑱	400-35768	⑩⑪	400-35778	⑩⑭	B1402-528-LAL	⑩⑭	B1402-528-LAR				
M	5/8	15.9	⑲	400-35769	⑩⑫	400-35779	⑩⑮	B1402-528-MAL	⑩⑮	B1402-528-MAR				
N	3/4	19.1	⑳	400-35770	⑩⑬	400-35780	⑩⑯	B1402-528-NAL	⑩⑯	B1402-528-NAR				
P	7/8	22.2	㉑	400-71917	⑩⑭	400-71919	⑩⑰	B1402-528-PAL	⑩⑰	B1402-528-PAR				
Q	1	25.4	㉒	400-71921	⑩⑮	400-71923	⑩⑱	B1402-528-QAL	⑩⑱	B1402-528-QAR				
Stitch spec. 縫 仕 様	S	Spec.common		Spec.common		Spec.common		Spec.common		Spec.common				
	G	仕 様 共 通		仕 様 共 通		仕 様 共 通		仕 様 共 通		仕 様 共 通		仕 様 共 通		

Needle gauge size 針 幅			Needle clamp asm.(for DP 1 7) 針 留 組 (D P 1 7 用)								Sliding plate asm. (Left) 滑り板(左)組		Sliding plate asm. (Right) 滑り板(右)組					
Code コード			Needle clamp asm. (Left) 針 留(左)組 		Needle clamp asm. (Right) 針 留(右)組 		Needle clamp asm. (Left) 針 留(左)組 		Needle clamp asm. (Right) 針 留(右)組 									
	inch	mm	No.	Part No.	No.	Part No.	No.	Part No.	No.	Part No.	No.	Part No.	No.	Part No.				
B	1/8	3.2	⑭④	400-35877	⑭⑤	400-35878	⑭⑧	B1402-526-BA0-A	⑭⑧	B1402-526-BA0-A	⑭⑩	400-25247	⑭③	400-25235				
C	5/32	4.0	⑭⑤	400-26063	⑭⑥	400-26084	⑭⑨	B1402-526-CA0-A	⑭⑨	B1402-526-CA0-A								
D	3/16	4.8	⑭⑥	400-26065	⑭⑦	400-26086	⑭⑩	B1402-526-DAL-A	⑭⑩	B1402-526-DAR-A								
E	7/32	5.6	⑭⑦	400-26067	⑭⑧	400-26088	⑭⑪	102-28559	⑭⑪	102-28567								
F	1/4	6.4	⑭⑧	400-26069	⑭⑨	400-26090	⑭⑫	B1402-526-FAL-A	⑭⑫	B1402-526-FAR-A								
G	9/32	7.1	⑭⑨	400-26070	⑭⑩	400-26091	⑭⑬	B1402-526-GAL-A	⑭⑬	B1402-526-GAR-A								
H	5/16	7.9	⑭⑩	400-26072	⑭⑪	400-26093	⑭⑭	B1402-526-HAL-A	⑭⑭	B1402-526-HAR-A								
K	3/8	9.5	⑭⑪	400-26074	⑭⑫	400-26095	⑭⑮	B1402-526-KAL-A	⑭⑮	B1402-526-KAR-A								
L	1/2	12.7	⑭⑫	400-26076	⑭⑬	400-26097	⑭⑯	B1402-526-LAL-A	⑭⑯	B1402-526-LAR-A								
M	5/8	15.9	⑭⑬	400-26078	⑭⑭	400-26099	⑭⑰	102-28856	⑭⑰	102-28864								
N	3/4	19.1	⑭⑭	400-26080	⑭⑮	400-26101	⑭⑱	102-28955	⑭⑱	102-28963								
P	7/8	22.2	—	—	—	—	—	—	—	⑭⑲					400-25248	⑭⑲	400-25236	
Q	1	25.4	⑭⑮	400-26082	⑭⑯	400-26103	⑭⑱	102-29151	⑭⑱	102-29169					⑭⑲	400-25249	⑭⑲	400-25239
Stitch spec. 縫 仕 様	S	Spec.common		Spec.common		★		★		Spec.common					Spec.common			
	G	仕 様 共 通		仕 様 共 通						仕 様 共 通		仕 様 共 通						





No.	品番	品名	備考	子部品	消耗品	個数
1	40061270	FEED_DOG_TYPE-S 1/8				1.00
2	40061271	FEED_DOG_TYPE-S 5/32				1.00
3	40061272	FEED_DOG_TYPE-S 3/16				1.00
4	40061273	FEED_DOG_TYPE-S 7/32				1.00
5	40061274	FEED_DOG_TYPE-S 1/4				1.00
6	40061275	FEED_DOG_TYPE-S 9/32				1.00
7	40061276	FEED_DOG_TYPE-S 5/16				1.00
8	40061277	FEED_DOG_TYPE-S 3/8				1.00
9	40061278	FEED_DOG_TYPE-S 1/2				1.00
10	40061279	FEED_DOG_TYPE-S 5/8				1.00
11	40061280	FEED_DOG_TYPE-S 3/4				1.00
12	40061281	FEED_DOG_TYPE-S 7/8				1.00
13	40061282	FEED_DOG_TYPE-S 1				1.00
14	40035890	FEED_DOG_TYPE-S 1/8				1.00
15	40025817	FEED_DOG_TYPE-S 5/32				1.00
16	40025818	FEED_DOG_TYPE-S 3/16				1.00
17	40025819	FEED_DOG_TYPE-S 7/32				1.00
18	40026715	FEED_DOG_TYPE-S 1/4				1.00
19	40025820	FEED_DOG_TYPE-S 9/32				1.00
20	40025821	FEED_DOG_TYPE-S 5/16				1.00
21	40025822	FEED_DOG_TYPE-S 3/8				1.00
22	40025824	FEED_DOG_TYPE-S 1/2				1.00
23	40025825	FEED_DOG_TYPE-S 5/8				1.00
24	40025826	FEED_DOG_TYPE-S 3/4				1.00
25	40025827	FEED_DOG_TYPE-S 7/8				1.00
26	40025828	FEED_DOG_TYPE-S 1				1.00
27	40053705	FEED_DOG_TYPE_7G_1/8				1.00
28	40071911	FEED_DOG_7G_5/32				1.00
29	40035891	FEED_DOG_TYPE_7G_3/16				1.00
30	40050009	FEED_DOG_TYPE_7G_7/32				1.00
31	40035892	FEED_DOG_TYPE_7G_1/4				1.00
32	40050010	FEED_DOG_TYPE_7G_9/32				1.00
33	40050011	FEED_DOG_TYPE_7G_5/16				1.00
34	40035893	FEED_DOG_TYPE_7G_3/8				1.00
35	40035894	FEED_DOG_TYPE_7G_1/2				1.00
36	40071912	FEED_DOG_7G_5/8				1.00
37	40035895	FEED_DOG_TYPE_7G_3/4				1.00
38	40071913	FEED_DOG_7G_7/8				1.00
39	40071914	FEED_DOG_7G_1				1.00
40	40053705	FEED_DOG_TYPE_7G_1/8				1.00
41	40025831	FEED_DOG_TYPE_7G_3/16				1.00
42	40025832	FEED_DOG_TYPE_7G_7/32				1.00
43	40025833	FEED_DOG_TYPE_7G_1/4				1.00
44	40025834	FEED_DOG_TYPE_7G_9/32				1.00
45	40025835	FEED_DOG_TYPE_7G_5/16				1.00
46	40025836	FEED_DOG_TYPE_7G_3/8				1.00
47	40025838	FEED_DOG_TYPE_7G_1/2				1.00
48	40025839	FEED_DOG_TYPE_7G_5/8				1.00
49	40025840	FEED_DOG_TYPE_7G_3/4				1.00
50	40025841	FEED_DOG_TYPE_7G_7/8				1.00

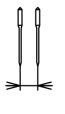

51	40025842	FEED_DOG_TYPE_7G_1				1.00
52	40035896	PRESSER FOOT ASM.				1.00
53	40035897	PRESSER FOOT ASM.				1.00
54	22640353	PRESSER FOOT ASM.				1.00
55	22640452	PRESSER FOOT ASM.				1.00
56	22640551	PRESSER FOOT ASM.				1.00
57	22640759	PRESSER FOOT ASM.				1.00
58	22640858	PRESSER FOOT ASM.				1.00
59	22640957	PRESSER FOOT ASM.				1.00
60	22641252	PRESSER FOOT ASM.				1.00
61	22641351	PRESSER FOOT ASM.				1.00
62	22641450	PRESSER FOOT ASM.				1.00
63	22641658	PRESSER FOOT ASM.				1.00
64	22641757	PRESSER FOOT ASM.				1.00
65	40071909	PRESSER_FOOT_ASM_G_5/32				1.00
66	22816557	TIP-DIVIDED PRESSER ASM. 3/16				1.00
67	22816656	TIP-DIVIDED PRESSER ASM. 7/32				1.00
68	22816755	PRESSER FOOT ASM. 1/4				1.00
69	22816854	TIP-DIVIDED PRESSER ASM. 9/32				1.00
70	22816953	TIP-DIVIDED PRESSER ASM. 5/16				1.00
71	22817050	PRESSER FOOT ASM. D=2.4 (3/8)				1.00
72	22817159	PRESSER FOOT ASM. D=2.4 (1/2)				1.00
73	40033945	TIP-DIVIDED_PRESSER_ASM_5/8				1.00
74	40033947	TIP-DIVIDED_PRESSER_ASM_3/4				1.00
75	40033949	TIP-DIVIDED_PRESSER_ASM_7/8				1.00
76	40033951	TIP-DIVIDED_PRESSER_ASM_1				1.00
77	40035881	THROAT_PLATE_TRIM_1/8				1.00
78	40025485	THROAT_PLATE_TRIM 5/32				1.00
79	40025490	THROAT_PLATE_TRIM-3/16				1.00
80	40025491	THROAT_PLATE_TRIM-7/32				1.00
81	40025492	THROAT_PLATE_TRIM-1/4				1.00
82	40025493	THROAT_PLATE_TRIM-9/32				1.00
83	40025494	THROAT_PLATE_TRIM-5/16				1.00
84	40025495	THROAT_PLATE_TRIM-3/8				1.00
85	40025498	THROAT_PLATE_TRIM-1/2				1.00
86	40025499	THROAT_PLATE_TRIM-5/8				1.00
87	40025500	THROAT_PLATE_TRIM-3/4				1.00
88	40025502	THROAT_PLATE_TRIM-7/8				1.00
89	40025503	THROAT_PLATE_TRIM-1				1.00
90	40035761	ASSY_NEEDLE_CLAMP_L(1/8)				1.00
91	40035762	ASSY_NEEDLE_CLAMP_L(5/32)				1.00
92	40035763	ASSY_NEEDLE_CLAMP_L(3/16)				1.00
93	40035764	ASSY_NEEDLE_CLAMP_L(7/32)				1.00
94	40029561	ASSY_NEEDLE_CLAMP_L(1/4)				1.00
95	40035765	ASSY_NEEDLE_CLAMP_L(9/32)				1.00
96	40035766	ASSY_NEEDLE_CLAMP_L(5/16)				1.00
97	40035767	ASSY_NEEDLE_CLAMP_L(3/8)				1.00
98	40035768	ASSY_NEEDLE_CLAMP_L(1/2)				1.00
99	40035769	ASSY_NEEDLE_CLAMP_L(5/8)				1.00
100	40035770	ASSY_NEEDLE_CLAMP_L(3/4)				1.00
101	40071917	ASSY_NEEDLE_CLAMP_L_7/8				1.00

102	40071921	ASSY_NEEDLE_CLAMP_L_1				1.00
103	40035771	ASSY_NEEDLE_CLAMP_R(1/8)				1.00
104	40035772	ASSY_NEEDLE_CLAMP_R(5/32)				1.00
105	40035773	ASSY_NEEDLE_CLAMP_R(3/16)				1.00
106	40035774	ASSY_NEEDLE_CLAMP_R(7/32)				1.00
107	40029562	ASSY_NEEDLE_CLAMP_R(1/4)				1.00
108	40035775	ASSY_NEEDLE_CLAMP_R(9/32)				1.00
109	40035776	ASSY_NEEDLE_CLAMP_R(5/16)				1.00
110	40035777	ASSY_NEEDLE_CLAMP_R(3/8)				1.00
111	40035778	ASSY_NEEDLE_CLAMP_R(1/2)				1.00
112	40035779	ASSY_NEEDLE_CLAMP_R(5/8)				1.00
113	40035780	ASSY_NEEDLE_CLAMP_R(3/4)				1.00
114	40071919	ASSY_NEEDLE_CLAMP_R_7/8				1.00
115	40071923	ASSY_NEEDLE_CLAMP_R_1				1.00
116	B1402528BA0A	NEEDLE CLAMP ASM. 1/8				1.00
117	B1402528CA0A	NEEDLE CLAMP ASM. 5/32				1.00
118	B1402528DALA	NEEDLE CLAMP ASM. LEFT				1.00
119	B1402528EAL	NEEDLE CLAMP ASM. 7/32				1.00
120	B1402528FALA	NEEDLE CLAMP ASM. 1/4				1.00
121	B1402528GAL	NEEDLE CLAMP ASM., LEFT				1.00
122	B1402528HALA	NEEDLE CLAMP ASM. 5/16				1.00
123	B1402528KALA	NEEDLE CLAMP ASM. 3/8				1.00
124	B1402528LAL	NEEDLE CLAMP ASM., LEFT 1/2				1.00
125	B1402528MAL	NEEDLE CLAMP ASM., LEFT 5/8				1.00
126	B1402528NAL	NEEDLE CLAMP ASM., LEFT 3/4				1.00
127	B1402528PAL	NEEDLE CLAMP ASM. LEFT 7/8				1.00
128	B1402528QAL	NEEDLE CLAMP ASM., LEFT 1				1.00
129	B1402528DARA	NEEDLE CLAMP ASM. RIGHT				1.00
130	B1402528EAR	NEEDLE CLAMP ASM. 7/32				1.00
131	B1402528FARA	NEEDLE CLAMP ASM. 1/4				1.00
132	B1402528GAR	NEEDLE CLAMP ASM., RIGHT				1.00
133	B1402528HARA	NEEDLE CLAMP ASM. 5/16				1.00
134	B1402528KARA	NEEDLE CLAMP ASM. 3/8				1.00
135	B1402528LAR	NEEDLE CLAMP ASM., RIGHT 1/2				1.00
136	B1402528MAR	NEEDLE CLAMP ASM., RIGHT 5/8				1.00
137	B1402528NAR	NEEDLE CLAMP ASM., RIGHT 3/4				1.00
138	B1402528PAR	NEEDLE CLAMP ASM. RIGHT 7/8				1.00
139	B1402528QAR	NEEDLE CLAMP ASM., RIGHT 1				1.00
140	40042880	ASSY_SLIDE_PLATE_F				1.00
141	40051633	ASSY_SLIDE_PLATE_L				1.00
142	40045729	ASSY_SIDE_PLATE-L-B				1.00
143	40045730	ASSY_SIDE_PLATE-L-C				1.00
144	40035877	ASSY_NEEDLE_CLAMP_L(1/8)				1.00
145	40026063	ASSY_NEEDLE_CLAMP_L(5/32)				1.00
146	40026065	ASSY_NEEDLE_CLAMP_L(3/16)				1.00
147	40026067	ASSY_NEEDLE_CLAMP_L(7/32)				1.00
148	40026069	ASSY_NEEDLE_CLAMP_L(1/4)				1.00
149	40026070	ASSY_NEEDLE_CLAMP_L(9/32)				1.00
150	40026072	ASSY_NEEDLE_CLAMP_L(5/16)				1.00
151	40026074	ASSY_NEEDLE_CLAMP_L(3/8)				1.00
152	40026076	ASSY_NEEDLE_CLAMP_L(1/2)				1.00

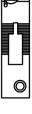
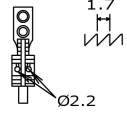
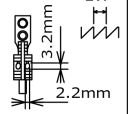
153	40026078	ASSY_NEEDLE_CLAMP_L(5/8)				1.00
154	40026080	ASSY_NEEDLE_CLAMP_L(3/4)				1.00
155	40026082	ASSY_NEEDLE_CLAMP_L(1)				1.00
156	40035878	ASSY_NEEDLE_CLAMP_R(1/8)				1.00
157	40026084	ASSY_NEEDLE_CLAMP_R(5/32)				1.00
158	40026086	ASSY_NEEDLE_CLAMP_R(3/16)				1.00
159	40026088	ASSY_NEEDLE_CLAMP_R(7/32)				1.00
160	40026090	ASSY_NEEDLE_CLAMP_R(1/4)				1.00
161	40026091	ASSY_NEEDLE_CLAMP_R(9/32)				1.00
162	40026093	ASSY_NEEDLE_CLAMP_R(5/16)				1.00
163	40026095	ASSY_NEEDLE_CLAMP_R(3/8)				1.00
164	40026097	ASSY_NEEDLE_CLAMP_R(1/2)				1.00
165	40026099	ASSY_NEEDLE_CLAMP_R(5/8)				1.00
166	40026101	ASSY_NEEDLE_CLAMP_R(3/4)				1.00
167	40026103	ASSY_NEEDLE_CLAMP_R(1)				1.00
168	B1402526BA0A	NEEDLE CLAMP ASM. 1/8				1.00
169	B1402526CA0A	NEEDLE CLAMP ASM. 5/32				1.00
170	B1402526DALA	NEEDLE CLAMP LEFT ASM. 3/16				1.00
171	10228559	NEEDLE CLAMP ASM. LEFT 7/32				1.00
172	B1402526FALA	NEEDLE CLAMP LEFT ASM. 1/4				1.00
173	B1402526GALA	NEEDLE CLAMP LEFT ASM. 9/32				1.00
174	B1402526HALA	NEEDLE CLAMP LEFT ASM. 5/16				1.00
175	B1402526KALA	NEEDLE CLAMP LEFT ASM. 3/8				1.00
176	B1402526LALA	NEEDLE CLAMP LEFT ASM.				1.00
177	10228856	NEEDLE CLAMP ASM. LEFT 5/8				1.00
178	10228955	NEEDLE CLAMP ASM. LEFT 3/4				1.00
179	10229151	NEEDLE CLAMP ASM. LEFT 1				1.00
180	B1402526DARA	NEEDLE CLAMP RIGHT ASM. 3/16				1.00
181	10228567	NEEDLE CLAMP ASM. RIGHT 7/32				1.00
182	B1402526FARA	NEEDLE CLAMP RIGHT ASM. 1/4				1.00
183	B1402526GARA	NEEDLE CLAMP RIGHT ASM. 9/32				1.00
184	B1402526HARA	NEEDLE CLAMP RIGHT ASM. 5/16				1.00
185	B1402526KARA	NEEDLE CLAMP RIGHT ASM. 3/8				1.00
186	B1402526LARA	NEEDLE CLAMP RIGHT ASM.				1.00
187	10228864	NEEDLE CLAMP ASM. RIGHT 5/8				1.00
188	10228963	NEEDLE CLAMP ASM. RIGHT 3/4				1.00
189	10229169	NEEDLE CLAMP ASM. RIGHT 1				1.00
190	40025247	ASSY_SLIDE_PLATE-L-A				1.00
191	40025248	ASSY_SLIDE_PLATE-L-B				1.00
192	40025249	ASSY_SLIDE_PLATE-L-C				1.00
193	40025235	ASSY_SLIDE_PLATE-R-A				1.00
194	40025236	ASSY_SLIDE_PLATE-R-B				1.00
195	40025239	ASSY_SLIDE_PLATE-R-C				1.00

# TABLE OF EXCHANGING GAUGE PARTS (FOR LH-3578)

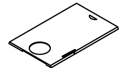
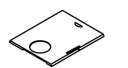
Needle gauge size 針 幅			Presser foot asm. 押 さ え(組)		Throat plate 針 板		Feed dog 送 り 歯				Needle clamp asm. 針 留 組	
Code コード			(Tip-divided) (移動式先割れ) 						Option オプション 			
	inch	mm	No.	Part No.	No.	Part No.	No.	Part No.	No.	Part No.	No.	Part No.
B	1/8	3.2	①	400-35896	⑱	400-72337	⑳	B1613-512-B0H	—	—	㉑	101-47650
C	5/32	4.0	②	400-71909	㉒	400-72338	㉓	B1613-512-C0H	—	—	㉔	101-47759
D	3/16	4.8	③	228-16557	㉕	226-25305	㉖	B1613-512-D0H	㉗	400-25801	㉘	101-47858
E	7/32	5.6	④	228-16656	㉙	226-25404	㉚	B1613-512-E0H	㉛	400-25802	㉜	101-47957
F	1/4	6.4	⑤	228-16755	㉝	226-25503	㉞	B1613-512-F0H	㉟	400-25803	㊱	101-48054
G	9/32	7.1	⑥	228-16854	㊲	226-25602	㊳	B1613-512-G0H	㊴	400-25804	㊵	101-48153
H	5/16	7.9	⑦	228-16953	㊶	226-25701	㊷	B1613-512-H0H	㊸	400-25805	㊹	101-48252
K	3/8	9.5	⑧	228-17050	㊺	226-25800	㊻	B1613-512-K0H	㊼	400-25806	㊽	101-48351
W	7/16	11.1	⑨	400-33941	㊾	226-25909	㊿	400-75311	㉀	400-25807	㉁	101-48450
L	1/2	12.7	⑩	228-17159	㉂	226-26006	㉃	B1613-512-L0H	㉄	400-25808	㉅	101-48559
M	5/8	15.9	⑪	400-33945	㉆	226-26105	㉇	B1613-512-M0H	㉈	400-25809	㉉	101-48658
N	3/4	19.1	⑫	400-33947	㉊	226-26204	㉋	B1613-512-N0H	㉌	400-25810	㉍	101-48757
P	7/8	22.2	⑬	400-33949	㉎	226-26303	㉏	B1613-512-P0H	㉐	400-25811	㉑	101-48856
Q	1	25.4	⑭	400-33951	㉒	226-26402	㉓	B1613-512-Q0H	㉔	400-25812	㉕	101-48955
R	1-1/8	28.6	⑮	400-33953	㉖	226-26501	㉗	B1613-512-R0H	㉘	400-25813	㉙	101-49052
S	1-1/4	31.8	⑯	400-33955	㉚	226-26600	㉛	B1613-512-S0H	㉜	400-25814	㉝	101-49151
T	1-3/8	34.9	⑰	400-33957	㉞	226-26709	㉟	B1613-512-T0H	㊱	400-25815	㊲	101-49250
U	1-1/2	38.1	⑱	400-33959	㊳	226-26808	㊴	B1613-512-U0H	㊵	400-25816	㊶	101-49359
Stitch spec. 縫 仕 様			Type G G 仕 様									

Needle gauge size 針 幅			Sliding plate asm. (Left) 滑 り 板(左)組		Sliding plate asm. (Right) 滑 り 板(右)組		Sliding plate asm. (Front) 滑 り 板(前)組		Sliding plate asm. (Left) 滑 り 板(左)組		
Code コード									Option オプション 		
	inch	mm	No.	Part No.	No.	Part No.	No.	Part No.	No.	Part No.	
B	1/8	3.2	⑨	226-01058	⑨	226-00555	⑨	400-42874	⑨	400-51633	
C	5/32	4.0									
D	3/16	4.8									
E	7/32	5.6									
F	1/4	6.4									
G	9/32	7.1									
H	5/16	7.9									
K	3/8	9.5									
L	1/2	12.7									
M	5/8	15.9	⑩	226-01157	⑩	226-00654	⑩	400-42874	⑩	400-45729	
N	3/4	19.1	⑪	226-01256	⑪	226-00753	⑪	400-42874	⑪	400-45730	
P	7/8	22.2									
Q	1	25.4									
R	1-1/8	28.6	⑫	226-01355	⑫	226-00852	⑫	400-42874	⑫	400-45731	
S	1-1/4	31.8									
T	1-3/8	34.9									
U	1-1/2	38.1									
Stitch spec. 縫 仕 様			Type G G 仕 様								





No.	品番	品名	備考	子部品	消耗品	個数
1	40035896	PRESSER FOOT ASM.				1.00
2	40071909	PRESSER_FOOT_ASM_G_5/32				1.00
3	22816557	TIP-DIVIDED PRESSER ASM. 3/16				1.00
4	22816656	TIP-DIVIDED PRESSER ASM. 7/32				1.00
5	22816755	PRESSER FOOT ASM. 1/4				1.00
6	22816854	TIP-DIVIDED PRESSER ASM. 9/32				1.00
7	22816953	TIP-DIVIDED PRESSER ASM. 5/16				1.00
8	22817050	PRESSER FOOT ASM. D=2.4 (3/8)				1.00
9	40033941	TIP-DIVIDED_PRESSER_ASM_7/16				1.00
10	22817159	PRESSER FOOT ASM. D=2.4 (1/2)				1.00
11	40033945	TIP-DIVIDED_PRESSER_ASM_5/8				1.00
12	40033947	TIP-DIVIDED_PRESSER_ASM_3/4				1.00
13	40033949	TIP-DIVIDED_PRESSER_ASM_7/8				1.00
14	40033951	TIP-DIVIDED_PRESSER_ASM_1				1.00
15	40033953	TIP-DIVIDED_PRESSER_ASM_1_1/8				1.00
16	40033955	TIP-DIVIDED_PRESSER_ASM_1_1/4				1.00
17	40033957	TIP-DIVIDED_PRESSER_ASM_1_3/8				1.00
18	40033959	TIP-DIVIDED_PRESSER_ASM_1_1/2				1.00
19	40072337	THROAT_PLATE_G_1/8				1.00
20	40072338	THROAT_PLATE_G_5/32				1.00
21	22625305	THROAT PLATE 3/16 (4.8MM)				1.00
22	22625404	THROAT PLATE 7/32 (5.6MM)				1.00
23	22625503	THROAT PLATE 1/4				1.00
24	22625602	THROAT PLATE 9/32 (7.1MM)				1.00
25	22625701	THROAT PLATE 5/16 (7.9MM)				1.00
26	22625800	THROAT PLATE 3/8 (9.5MM)				1.00
27	22625909	THROT PLATE 7/16 (11.1M)				1.00
28	22626006	THROAT PLATE 1/2 (12.7MM)				1.00
29	22626105	THROAT PLATE 5/8 (15.9MM)				1.00
30	22626204	THROAT PLATE 3/4 (19.1MM)				1.00
31	22626303	THROAT PLATE 7/8 (22.2MM)				1.00
32	22626402	THROAT PLATE 1 (25.4MM)				1.00
33	22626501	THROAT PLATE 1.1/8 (28.6MM)				1.00
34	22626600	THROAT PLATE 1.1/4 (31.8MM)				1.00
35	22626709	THROAT PLATE 1.3/8 (34.9MM)				1.00
36	22626808	THROAT PLATE 1.1/2 (38.1MM)				1.00
37	B1613512B0H	FEED DOG (1/8)				1.00
38	B1613512C0H	FEED DOG 5/32				1.00
39	B1613512D0H	FEED DOG 3/16				1.00
40	B1613512E0H	FEED DOG 7/32				1.00
41	B1613512F0H	FEED DOG 1/4				1.00
42	B1613512G0H	FEED DOG 9/32				1.00
43	B1613512H0H	FEED DOG 5/16				1.00
44	B1613512K0H	FEED DOG 3/8				1.00
45	40075311	FEED_DOG_TYPE_G_7/16				1.00
46	B1613512L0H	FEED DOG 1/2				1.00
47	B1613512M0H	FEED DOG 5/8				1.00
48	B1613512N0H	FEED DOG 3/4				1.00
49	B1613512P0H	FEED DOG 7/8				1.00
50	B1613512Q0H	FEED DOG 1				1.00



51	B1613512R0H	FEED DOG 1-1/8				1.00
52	B1613512S0H	FEED DOG 1-1/4				1.00
53	B1613512T0H	FEED DOG 1-3/8				1.00
54	B1613512U0H	FEED DOG 1-1/2				1.00
55	40025801	FEED_DOG_TYPE_G_3/16				1.00
56	40025802	FEED_DOG_TYPE_G_7/32				1.00
57	40025803	FEED_DOG_TYPE_G_1/4				1.00
58	40025804	FEED_DOG_TYPE_G_9/32				1.00
59	40025805	FEED_DOG_TYPE_G_5/16				1.00
60	40025806	FEED_DOG_TYPE_G_3/8				1.00
61	40025807	FEED_DOG_TYPE_G_7/16				1.00
62	40025808	FEED_DOG_TYPE_G_1/2				1.00
63	40025809	FEED_DOG_TYPE_G_5/8				1.00
64	40025810	FEED_DOG_TYPE_G_3/4				1.00
65	40025811	FEED_DOG_TYPE_G_7/8				1.00
66	40025812	FEED_DOG_TYPE_G_1				1.00
67	40025813	FEED_DOG_TYPE_G_1-1/8				1.00
68	40025814	FEED_DOG_TYPE_G_1-1/4				1.00
69	40025815	FEED_DOG_TYPE_G_1-3/8				1.00
70	40025816	FEED_DOG_TYPE_G_1-1/2				1.00
71	10147650	NEEDLE CLAMP ASM. 1/8				1.00
72	10147759	NEEDLE CLAMP ASM. 5/32				1.00
73	10147858	NEEDLE CLAMP ASM. 3/16				1.00
74	10147957	NEEDLE CLAMP ASM. 7/32				1.00
75	10148054	NEEDLE CLAMP ASM. 1/4				1.00
76	10148153	NEEDLE CLAMP ASM. 9/32				1.00
77	10148252	NEEDLE CLAMP ASM. 5/16				1.00
78	10148351	NEEDLE CLAMP ASM. 3/8				1.00
79	10148450	NEEDLE CLAMP ASM. 7/16				1.00
80	10148559	NEEDLE CLAMP ASM. 1/2				1.00
81	10148658	NEEDLE CLAMP ASM. 5/8				1.00
82	10148757	NEEDLE CLAMP ASM. 3/4				1.00
83	10148856	NEEDLE CLAMP ASM. 7/8				1.00
84	10148955	NEEDLE CLAMP ASM. 1				1.00
85	10149052	NEEDLE CLAMP ASM. 1-1/8				1.00
86	10149151	NEEDLE CLAMP ASM. 1-1/4				1.00
87	10149250	NEEDLE CLAMP ASM. 1-3/8				1.00
88	10149359	NEEDLE CLAMP ASM. 1-1/2				1.00
89	22601058	BED SLIDE LEFT, ASM., A				1.00
90	22601157	LEFT SLIDER PLATE B ASM.				1.00
91	22601256	BED SLIDE LEFT, ASM., C				1.00
92	22601355	BED SLIDE LEFT, ASM., C				1.00
93	22600555	BED SLIDE RIGHT, ASM., A				1.00
94	22600654	RIGHT SLIDER PLATE B ASM.				1.00
95	22600753	BED SLIDE RIGHT, ASM., C				1.00
96	22600852	BED SLIDE RIGHT, ASM., D				1.00
97	40042874	ASSY_SLIDE_PLATE_F_STANDARD				1.00
98	40051633	ASSY_SLIDE_PLATE_L				1.00
99	40045729	ASSY_SIDE_PLATE-L-B				1.00
100	40045730	ASSY_SIDE_PLATE-L-C				1.00
101	40045731	ASSY_SIDE_PLATE-L-D				1.00

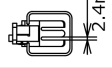

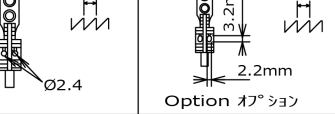

# TABLE OF EXCHANGING GAUGE PARTS (FOR LH-3578-7)

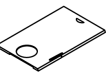

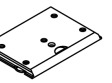
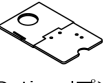

Needle gauge size 針 幅			Presser foot asm. 押 さ え(組)		Throat plate 針 板		Feed dog 送 り 歯				Needle clamp asm. 針 留 組	
Code コード			 (Tip-divided) (移動式先割れ) 2.4mm				 1.7 1.7 Ø2.4 3.2mm 2.2mm Option オプション					
	inch	mm	No.	Part No.	No.	Part No.	No.	Part No.	No.	Part No.	No.	Part No.
B	1/8	3.2	(1)	400-35896	(15)	400-35881	(29)	400-53705	(29)	400-53705	(54)	101-47650
C	5/32	4.0	(2)	400-71909	(16)	400-25485	(30)	400-71911	—	—	(55)	101-47759
D	3/16	4.8	(3)	228-16557	(17)	400-25490	(31)	400-35891	(42)	400-25831	(56)	101-47858
E	7/32	5.6	(4)	228-16656	(18)	400-25491	(32)	400-50009	(43)	400-25832	(57)	101-47957
F	1/4	6.4	(5)	228-16755	(19)	400-25492	(33)	400-35892	(44)	400-25833	(58)	101-48054
G	9/32	7.1	(6)	228-16854	(20)	400-25493	(34)	400-50010	(45)	400-25834	(59)	101-48153
H	5/16	7.9	(7)	228-16953	(21)	400-25494	(35)	400-50011	(46)	400-25835	(60)	101-48252
K	3/8	9.5	(8)	228-17050	(22)	400-25495	(36)	400-35893	(47)	400-25836	(61)	101-48351
W	7/16	11.1	(9)	400-33941	(23)	400-25496	—	—	(48)	400-25837	(62)	101-48450
L	1/2	12.7	(10)	228-17159	(24)	400-25498	(37)	400-35894	(49)	400-25838	(63)	101-48559
M	5/8	15.9	(11)	400-33945	(25)	400-25499	(38)	400-71912	(50)	400-25839	(64)	101-48658
N	3/4	19.1	(12)	400-33947	(26)	400-25500	(39)	400-35895	(51)	400-25840	(65)	101-48757
P	7/8	22.2	(13)	400-33949	(27)	400-25502	(40)	400-71913	(52)	400-25841	(66)	101-48856
Q	1	25.4	(14)	400-33951	(28)	400-25503	(41)	400-71914	(53)	400-25842	(67)	101-48955
Stitch spec. 縫 仕 様			Type G G 仕 様									





Needle gauge size 針 幅			Sliding plate asm. (Left) 滑 り 板(左)組		Sliding plate asm. (Right) 滑 り 板(右)組		Sliding plate asm. (Front) 滑 り 板(前) 組		Sliding plate asm. (Left) 滑 り 板(左)組		
Code コード									 Option オプション		
	inch	mm	No.	Part No.	No.	Part No.	No.	Part No.	No.	Part No.	
B	1/8	3.2	(68)	400-25247	(71)	400-25235	(74)	400-42880	(75)	400-51633	
C	5/32	4.0									
D	3/16	4.8									
E	7/32	5.6									
F	1/4	6.4									
G	9/32	7.1									
H	5/16	7.9									
K	3/8	9.5									
W	7/16	11.1	(69)	400-25248	(72)	400-25236	(76)	400-45729			
L	1/2	12.7									
M	5/8	15.9									
N	3/4	19.1									
P	7/8	22.2	(70)	400-25249	(73)	400-25239	(77)	400-45730			
Q	1	25.4									
Stitch spec. 縫 仕 様			Type G G 仕 様								





No.	品番	品名	備考	子部品	消耗品	個数
1	40035896	PRESSER FOOT ASM.				1.00
2	40071909	PRESSER_FOOT_ASM_G_5/32				1.00
3	22816557	TIP-DIVIDED PRESSER ASM. 3/16				1.00
4	22816656	TIP-DIVIDED PRESSER ASM. 7/32				1.00
5	22816755	PRESSER FOOT ASM. 1/4				1.00
6	22816854	TIP-DIVIDED PRESSER ASM. 9/32				1.00
7	22816953	TIP-DIVIDED PRESSER ASM. 5/16				1.00
8	22817050	PRESSER FOOT ASM. D=2.4 (3/8)				1.00
9	40033941	TIP-DIVIDED_PRESSER_ASM_7/16				1.00
10	22817159	PRESSER FOOT ASM. D=2.4 (1/2)				1.00
11	40033945	TIP-DIVIDED_PRESSER_ASM_5/8				1.00
12	40033947	TIP-DIVIDED_PRESSER_ASM_3/4				1.00
13	40033949	TIP-DIVIDED_PRESSER_ASM_7/8				1.00
14	40033951	TIP-DIVIDED_PRESSER_ASM_1				1.00
15	40035881	THROAT_PLATE_TRIM_1/8				1.00
16	40025485	THROAT_PLATE_TRIM 5/32				1.00
17	40025490	THROAT_PLATE_TRIM-3/16				1.00
18	40025491	THROAT_PLATE_TRIM-7/32				1.00
19	40025492	THROAT_PLATE_TRIM-1/4				1.00
20	40025493	THROAT_PLATE_TRIM-9/32				1.00
21	40025494	THROAT_PLATE_TRIM-5/16				1.00
22	40025495	THROAT_PLATE_TRIM-3/8				1.00
23	40025496	THROAT_PLATE_TRIM-7/16				1.00
24	40025498	THROAT_PLATE_TRIM-1/2				1.00
25	40025499	THROAT_PLATE_TRIM-5/8				1.00
26	40025500	THROAT_PLATE_TRIM-3/4				1.00
27	40025502	THROAT_PLATE_TRIM-7/8				1.00
28	40025503	THROAT_PLATE_TRIM-1				1.00
29	40053705	FEED_DOG_TYPE_7G_1/8				1.00
30	40071911	FEED_DOG_7G_5/32				1.00
31	40035891	FEED_DOG_TYPE_7G_3/16				1.00
32	40050009	FEED_DOG_TYPE_7G_7/32				1.00
33	40035892	FEED_DOG_TYPE_7G_1/4				1.00
34	40050010	FEED_DOG_TYPE_7G_9/32				1.00
35	40050011	FEED_DOG_TYPE_7G_5/16				1.00
36	40035893	FEED_DOG_TYPE_7G_3/8				1.00
37	40035894	FEED_DOG_TYPE_7G_1/2				1.00
38	40071912	FEED_DOG_7G_5/8				1.00
39	40035895	FEED_DOG_TYPE_7G_3/4				1.00
40	40071913	FEED_DOG_7G_7/8				1.00
41	40071914	FEED_DOG_7G_1				1.00
42	40025831	FEED_DOG_TYPE_7G_3/16				1.00
43	40025832	FEED_DOG_TYPE_7G_7/32				1.00
44	40025833	FEED_DOG_TYPE_7G_1/4				1.00
45	40025834	FEED_DOG_TYPE_7G_9/32				1.00
46	40025835	FEED_DOG_TYPE_7G_5/16				1.00
47	40025836	FEED_DOG_TYPE_7G_3/8				1.00
48	40025837	FEED_DOG_TYPE_7G_7/16				1.00
49	40025838	FEED_DOG_TYPE_7G_1/2				1.00
50	40025839	FEED_DOG_TYPE_7G_5/8				1.00

51	40025840	FEED_DOG_TYPE_7G_3/4				1.00
52	40025841	FEED_DOG_TYPE_7G_7/8				1.00
53	40025842	FEED_DOG_TYPE_7G_1				1.00
54	10147650	NEEDLE CLAMP ASM. 1/8				1.00
55	10147759	NEEDLE CLAMP ASM. 5/32				1.00
56	10147858	NEEDLE CLAMP ASM. 3/16				1.00
57	10147957	NEEDLE CLAMP ASM. 7/32				1.00
58	10148054	NEEDLE CLAMP ASM. 1/4				1.00
59	10148153	NEEDLE CLAMP ASM. 9/32				1.00
60	10148252	NEEDLE CLAMP ASM. 5/16				1.00
61	10148351	NEEDLE CLAMP ASM. 3/8				1.00
62	10148450	NEEDLE CLAMP ASM. 7/16				1.00
63	10148559	NEEDLE CLAMP ASM. 1/2				1.00
64	10148658	NEEDLE CLAMP ASM. 5/8				1.00
65	10148757	NEEDLE CLAMP ASM. 3/4				1.00
66	10148856	NEEDLE CLAMP ASM. 7/8				1.00
67	10148955	NEEDLE CLAMP ASM. 1				1.00
68	40025247	ASSY_SLIDE_PLATE-L-A				1.00
69	40025248	ASSY_SLIDE_PLATE-L-B				1.00
70	40025249	ASSY_SLIDE_PLATE-L-C				1.00
71	40025235	ASSY_SLIDE_PLATE-R-A				1.00
72	40025236	ASSY_SLIDE_PLATE-R-B				1.00
73	40025239	ASSY_SLIDE_PLATE-R-C				1.00
74	40042880	ASSY_SLIDE_PLATE_F				1.00
75	40051633	ASSY_SLIDE_PLATE_L				1.00
76	40045729	ASSY_SIDE_PLATE-L-B				1.00
77	40045730	ASSY_SIDE_PLATE-L-C				1.00

# TABLE OF EXCHANGING GAUGE PARTS (FOR LH-3588)

Needle gauge size 針 幅			Needle clamp asm.(for DP 5) 針 留組(D P 5用)				Needle clamp asm.(for DP 1 7) 針 留組(D P 1 7用)			
Code コード			Needle clamp asm. (Left) 針 留(左)組 		Needle clamp asm. (Right) 針 留(右)組 		Needle clamp asm. (Left) 針 留(左)組 		Needle clamp asm. (Right) 針 留(右)組 	
			No.	Part No.	No.	Part No.	Option オプション	Option オプション	No.	Part No.
B	1/8	3.2	(1)	B1402-528-BA0-A	(1)	B1402-528-BA0-A	(25)	B1402-526-BA0-A	(25)	B1402-526-BA0-A
C	5/32	4.0	(2)	B1402-528-CA0-A	(2)	B1402-528-CA0-A	(26)	B1402-526-CA0-A	(26)	B1402-526-CA0-A
D	3/16	4.8	(3)	B1402-528-DAL-A	(14)	B1402-528-DAR-A	(27)	B1402-526-DAL-A	(37)	B1402-526-DAR-A
E	7/32	5.6	(4)	B1402-528-EAL	(15)	B1402-528-EAR	(28)	102-28559	(38)	102-28567
F	1/4	6.4	(5)	B1402-528-FAL-A	(16)	B1402-528-FAR-A	(29)	B1402-526-FAL-A	(39)	B1402-526-FAR-A
G	9/32	7.1	(6)	B1402-528-GAL	(17)	B1402-528-GAR	(30)	B1402-526-GAL-A	(40)	B1402-526-GAR-A
H	5/16	7.9	(7)	B1402-528-HAL-A	(18)	B1402-528-HAR-A	(31)	B1402-526-HAL-A	(41)	B1402-526-HAR-A
K	3/8	9.5	(8)	B1402-528-KAL-A	(19)	B1402-528-KAR-A	(32)	B1402-526-KAL-A	(42)	B1402-526-KAR-A
L	1/2	12.7	(9)	B1402-528-LAL	(20)	B1402-528-LAR	(33)	B1402-526-LAL-A	(43)	B1402-526-LAR-A
M	5/8	15.9	(10)	B1402-528-MAL	(21)	B1402-528-MAR	(34)	102-28856	(44)	102-28864
N	3/4	19.1	(11)	B1402-528-NAL	(22)	B1402-528-NAR	(35)	102-28955	(45)	102-28963
P	7/8	22.2	(12)	B1402-528-PAL	(23)	B1402-528-PAR	-	-	-	-
Q	1	25.4	(13)	B1402-528-QAL	(24)	B1402-528-QAR	(36)	102-29151	(46)	102-29169
Stitch spec. 縫 仕 様			Type G G 仕 様							

Needle gauge size 針 幅			Throat plate 針 板		Feed Dog 送 り 歯			Presser foot asm. 押 さ え(組)		
Code コード										
					No.	Part No.	No.	Part No.	No.	Part No.
B	1/8	3.2	(47)	400-72337	(61)	B1613-512-B0H	-	-	(87)	400-35896
C	5/32	4.0	(48)	400-72338	(62)	B1613-512-C0H	-	-	(88)	400-71909
D	3/16	4.8	(49)	226-25305	(63)	B1613-512-D0H	(75)	400-25801	(89)	228-16557
E	7/32	5.6	(50)	226-25404	(64)	B1613-512-E0H	(76)	400-25802	(90)	228-16656
F	1/4	6.4	(51)	226-25503	(65)	B1613-512-F0H	(77)	400-25803	(91)	228-16755
G	9/32	7.1	(52)	226-25602	(66)	B1613-512-G0H	(78)	400-25804	(92)	228-16854
H	5/16	7.9	(53)	226-25701	(67)	B1613-512-H0H	(79)	400-25805	(93)	228-16953
K	3/8	9.5	(54)	226-25800	(68)	B1613-512-K0H	(80)	400-25806	(94)	228-17050
W	7/16	11.1	(55)	226-25909	(69)	400-75311	(81)	400-25807	(95)	400-33941
L	1/2	12.7	(56)	226-26006	(70)	B1613-512-L0H	(82)	400-25808	(96)	228-17159
M	5/8	15.9	(57)	226-26105	(71)	B1613-512-M0H	(83)	400-25809	(97)	400-33945
N	3/4	19.1	(58)	226-26204	(72)	B1613-512-N0H	(84)	400-25810	(98)	400-33947
P	7/8	22.2	(59)	226-26303	(73)	B1613-512-P0H	(85)	400-25811	(99)	400-33949
Q	1	25.4	(60)	226-26402	(74)	B1613-512-Q0H	(86)	400-25812	(100)	400-33951
Stitch spec. 縫 仕 様			Type G G 仕 様							

Needle gauge size 針 幅			Sliding plate asm. (Left) 滑 り 板(左)組		Sliding plate asm. (Right) 滑 り 板(右)組		Sliding plate asm. (Front) 滑 り 板(前)組		Sliding plate asm. (Left) 滑 り 板(左)組	
Code コード										
			No.	Part No.	No.	Part No.	No.	Part No.	Option オプション	Option オプション
B	1/8	3.2	(101)	226-01058	(104)	226-00555	(107)	400-42874	(108)	400-51633
C	5/32	4.0								
D	3/16	4.8								
E	7/32	5.6								
F	1/4	6.4								
G	9/32	7.1	(102)	226-01157	(105)	226-00654	(109)	400-45729		
H	5/16	7.9								
K	3/8	9.5								
L	1/2	12.7								
M	5/8	15.9								
N	3/4	19.1	(103)	226-01256	(106)	226-00753	(110)	400-45730		
P	7/8	22.2								
Q	1	25.4								
Stitch spec. 縫 仕 様			Type G G 仕 様							





No.	品番	品名	備考	子部品	消耗品	個数
1	B1402528BA0A	NEEDLE CLAMP ASM. 1/8				1.00
2	B1402528CA0A	NEEDLE CLAMP ASM. 5/32				1.00
3	B1402528DALA	NEEDLE CLAMP ASM. LEFT				1.00
4	B1402528EAL	NEEDLE CLAMP ASM. 7/32				1.00
5	B1402528FALA	NEEDLE CLAMP ASM. 1/4				1.00
6	B1402528GAL	NEEDLE CLAMP ASM., LEFT				1.00
7	B1402528HALA	NEEDLE CLAMP ASM. 5/16				1.00
8	B1402528KALA	NEEDLE CLAMP ASM. 3/8				1.00
9	B1402528LAL	NEEDLE CLAMP ASM., LEFT 1/2				1.00
10	B1402528MAL	NEEDLE CLAMP ASM., LEFT 5/8				1.00
11	B1402528NAL	NEEDLE CLAMP ASM., LEFT 3/4				1.00
12	B1402528PAL	NEEDLE CLAMP ASM. LEFT 7/8				1.00
13	B1402528QAL	NEEDLE CLAMP ASM., LEFT 1				1.00
14	B1402528DARA	NEEDLE CLAMP ASM. RIGHT				1.00
15	B1402528EAR	NEEDLE CLAMP ASM. 7/32				1.00
16	B1402528FARA	NEEDLE CLAMP ASM. 1/4				1.00
17	B1402528GAR	NEEDLE CLAMP ASM., RIGHT				1.00
18	B1402528HARA	NEEDLE CLAMP ASM. 5/16				1.00
19	B1402528KARA	NEEDLE CLAMP ASM. 3/8				1.00
20	B1402528LAR	NEEDLE CLAMP ASM., RIGHT 1/2				1.00
21	B1402528MAR	NEEDLE CLAMP ASM., RIGHT 5/8				1.00
22	B1402528NAR	NEEDLE CLAMP ASM., RIGHT 3/4				1.00
23	B1402528PAR	NEEDLE CLAMP ASM. RIGHT 7/8				1.00
24	B1402528QAR	NEEDLE CLAMP ASM., RIGHT 1				1.00
25	B1402526BA0A	NEEDLE CLAMP ASM. 1/8				1.00
26	B1402526CA0A	NEEDLE CLAMP ASM. 5/32				1.00
27	B1402526DALA	NEEDLE CLAMP LEFT ASM. 3/16				1.00
28	10228559	NEEDLE CLAMP ASM. LEFT 7/32				1.00
29	B1402526FALA	NEEDLE CLAMP LEFT ASM. 1/4				1.00
30	B1402526GALA	NEEDLE CLAMP LEFT ASM. 9/32				1.00
31	B1402526HALA	NEEDLE CLAMP LEFT ASM. 5/16				1.00
32	B1402526KALA	NEEDLE CLAMP LEFT ASM. 3/8				1.00
33	B1402526LALA	NEEDLE CLAMP LEFT ASM.				1.00
34	10228856	NEEDLE CLAMP ASM. LEFT 5/8				1.00
35	10228955	NEEDLE CLAMP ASM. LEFT 3/4				1.00
36	10229151	NEEDLE CLAMP ASM. LEFT 1				1.00
37	B1402526DARA	NEEDLE CLAMP RIGHT ASM. 3/16				1.00
38	10228567	NEEDLE CLAMP ASM. RIGHT 7/32				1.00
39	B1402526FARA	NEEDLE CLAMP RIGHT ASM. 1/4				1.00
40	B1402526GARA	NEEDLE CLAMP RIGHT ASM. 9/32				1.00
41	B1402526HARA	NEEDLE CLAMP RIGHT ASM. 5/16				1.00
42	B1402526KARA	NEEDLE CLAMP RIGHT ASM. 3/8				1.00
43	B1402526LARA	NEEDLE CLAMP RIGHT ASM.				1.00
44	10228864	NEEDLE CLAMP ASM. RIGHT 5/8				1.00
45	10228963	NEEDLE CLAMP ASM. RIGHT 3/4				1.00
46	10229169	NEEDLE CLAMP ASM. RIGHT 1				1.00
47	40072337	THROAT_PLATE_G_1/8				1.00
48	40072338	THROAT_PLATE_G_5/32				1.00
49	22625305	THROAT PLATE 3/16 (4.8MM)				1.00
50	22625404	THROAT PLATE 7/32 (5.6MM)				1.00





51	22625503	THROAT PLATE 1/4				1.00
52	22625602	THROAT PLATE 9/32 (7.1MM)				1.00
53	22625701	THROAT PLATE 5/16 (7.9MM)				1.00
54	22625800	THROAT PLATE 3/8 (9.5MM)				1.00
55	22625909	THROT PLATE 7/16 (11.1M)				1.00
56	22626006	THROAT PLATE 1/2 (12.7MM)				1.00
57	22626105	THROAT PLATE 5/8 (15.9MM)				1.00
58	22626204	THROAT PLATE 3/4 (19.1MM)				1.00
59	22626303	THROAT PLATE 7/8 (22.2MM)				1.00
60	22626402	THROAT PLATE 1 (25.4MM)				1.00
61	B1613512B0H	FEED DOG (1/8)				1.00
62	B1613512C0H	FEED DOG 5/32				1.00
63	B1613512D0H	FEED DOG 3/16				1.00
64	B1613512E0H	FEED DOG 7/32				1.00
65	B1613512F0H	FEED DOG 1/4				1.00
66	B1613512G0H	FEED DOG 9/32				1.00
67	B1613512H0H	FEED DOG 5/16				1.00
68	B1613512K0H	FEED DOG 3/8				1.00
69	40075311	FEED_DOG_TYPE_G_7/16				1.00
70	B1613512L0H	FEED DOG 1/2				1.00
71	B1613512M0H	FEED DOG 5/8				1.00
72	B1613512N0H	FEED DOG 3/4				1.00
73	B1613512P0H	FEED DOG 7/8				1.00
74	B1613512Q0H	FEED DOG 1				1.00
75	40025801	FEED_DOG_TYPE_G_3/16				1.00
76	40025802	FEED_DOG_TYPE_G_7/32				1.00
77	40025803	FEED_DOG_TYPE_G_1/4				1.00
78	40025804	FEED_DOG_TYPE_G_9/32				1.00
79	40025805	FEED_DOG_TYPE_G_5/16				1.00
80	40025806	FEED_DOG_TYPE_G_3/8				1.00
81	40025807	FEED_DOG_TYPE_G_7/16				1.00
82	40025808	FEED_DOG_TYPE_G_1/2				1.00
83	40025809	FEED_DOG_TYPE_G_5/8				1.00
84	40025810	FEED_DOG_TYPE_G_3/4				1.00
85	40025811	FEED_DOG_TYPE_G_7/8				1.00
86	40025812	FEED_DOG_TYPE_G_1				1.00
87	40035896	PRESSER FOOT ASM.				1.00
88	40071909	PRESSER_FOOT_ASM_G_5/32				1.00
89	22816557	TIP-DIVIDED PRESSER ASM. 3/16				1.00
90	22816656	TIP-DIVIDED PRESSER ASM. 7/32				1.00
91	22816755	PRESSER FOOT ASM. 1/4				1.00
92	22816854	TIP-DIVIDED PRESSER ASM. 9/32				1.00
93	22816953	TIP-DIVIDED PRESSER ASM. 5/16				1.00
94	22817050	PRESSER FOOT ASM. D=2.4 (3/8)				1.00
95	40033941	TIP-DIVIDED_PRESSER_ASM_7/16				1.00
96	22817159	PRESSER FOOT ASM. D=2.4 (1/2)				1.00
97	40033945	TIP-DIVIDED_PRESSER_ASM_5/8				1.00
98	40033947	TIP-DIVIDED_PRESSER_ASM_3/4				1.00
99	40033949	TIP-DIVIDED_PRESSER_ASM_7/8				1.00
100	40033951	TIP-DIVIDED_PRESSER_ASM_1				1.00
101	22601058	BED SLIDE LEFT, ASM., A				1.00





102	22601157	LEFT SLIDER PLATE B ASM.				1.00
103	22601256	BED SLIDE LEFT, ASM., C				1.00
104	22600555	BED SLIDE RIGHT, ASM., A				1.00
105	22600654	RIGHT SLIDER PLATE B ASM.				1.00
106	22600753	BED SLIDE RIGHT, ASM., C				1.00
107	40042874	ASSY_SLIDE_PLATE_F_STANDARD				1.00
108	40051633	ASSY_SLIDE_PLATE_L				1.00
109	40045729	ASSY_SIDE_PLATE-L-B				1.00
110	40045730	ASSY_SIDE_PLATE-L-C				1.00

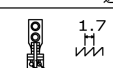

# TABLE OF EXCHANGING GAUGE PARTS (FOR LH-3588-7)

Needle gauge size 針 幅			Needle clamp asm. (for DP 5) 針 留組(D P 5用)				Needle clamp asm. (for DP 1 7) 針 留組(D P 1 7用)			
Code コード			Needle clamp asm. (Left) 針 留(左)組 		Needle clamp asm. (Right) 針 留(右)組 		Needle clamp asm. (Left) 針 留(左)組 		Needle clamp asm. (Right) 針 留(右)組 	
	inch	mm	No.	Part No.	No.	Part No.	Option オプション	Part No.	Option オプション	Part No.
B	1/8	3.2	(1)	B1402-528-BA0-A	(1)	B1402-528-BA0-A	(25)	B1402-526-BA0-A	(25)	B1402-526-BA0-A
C	5/32	4.0	(2)	B1402-528-CA0-A	(2)	B1402-528-CA0-A	(26)	B1402-526-CA0-A	(26)	B1402-526-CA0-A
D	3/16	4.8	(3)	B1402-528-DAL-A	(14)	B1402-528-DAR-A	(27)	B1402-526-DAL-A	(37)	B1402-526-DAR-A
E	7/32	5.6	(4)	B1402-528-EAL	(15)	B1402-528-EAR	(28)	102-28559	(38)	102-28567
F	1/4	6.4	(5)	B1402-528-FAL-A	(16)	B1402-528-FAR-A	(29)	B1402-526-FAL-A	(39)	B1402-526-FAR-A
G	9/32	7.1	(6)	B1402-528-GAL	(17)	B1402-528-GAR	(30)	B1402-526-GAL-A	(40)	B1402-526-GAR-A
H	5/16	7.9	(7)	B1402-528-HAL-A	(18)	B1402-528-HAR-A	(31)	B1402-526-HAL-A	(41)	B1402-526-HAR-A
K	3/8	9.5	(8)	B1402-528-KAL-A	(19)	B1402-528-KAR-A	(32)	B1402-526-KAL-A	(42)	B1402-526-KAR-A
L	1/2	12.7	(9)	B1402-528-LAL	(20)	B1402-528-LAR	(33)	B1402-526-LAL-A	(43)	B1402-526-LAR-A
M	5/8	15.9	(10)	B1402-528-MAL	(21)	B1402-528-MAR	(34)	102-28856	(44)	102-28864
N	3/4	19.1	(11)	B1402-528-NAL	(22)	B1402-528-NAR	(35)	102-28955	(45)	102-28963
P	7/8	22.2	(12)	B1402-528-PAL	(23)	B1402-528-PAR	-	-	-	-
Q	1	25.4	(13)	B1402-528-QAL	(24)	B1402-528-QAR	(36)	102-29151	(46)	102-29169
Stitch spec. 縫 仕 様			Type G G 仕 様							

Needle gauge size 針 幅			Throat plate 針 板		Feed Dog 送 り 歯				Presser foot asm. 押 さ え(組)	
Code コード					 1.7 Option オプション 3.2mm 1.7 2.2mm				 (Tip-divided) (移動式先割れ) 2.4mm	
	inch	mm	No.	Part No.	No.	Part No.	No.	Part No.	No.	Part No.
B	1/8	3.2	(47)	400-35881	(61)	400-53705	(61)	400-53705	(86)	400-35896
C	5/32	4.0	(48)	400-25485	(62)	400-71911	-	-	(87)	400-71909
D	3/16	4.8	(49)	400-25490	(63)	400-35891	(74)	400-25831	(88)	228-16557
E	7/32	5.6	(50)	400-25491	(64)	400-50009	(75)	400-25832	(89)	228-16656
F	1/4	6.4	(51)	400-25492	(65)	400-35892	(76)	400-25833	(90)	228-16755
G	9/32	7.1	(52)	400-25493	(66)	400-50010	(77)	400-25834	(91)	228-16854
H	5/16	7.9	(53)	400-25494	(67)	400-50011	(78)	400-25835	(92)	228-16953
K	3/8	9.5	(54)	400-25495	(68)	400-35893	(79)	400-25836	(93)	228-17050
W	7/16	11.1	(55)	400-25496	-	-	(80)	400-25837	(94)	400-33941
L	1/2	12.7	(56)	400-25498	(69)	400-35894	(81)	400-25838	(95)	228-17159
M	5/8	15.9	(57)	400-25499	(70)	400-71912	(82)	400-25839	(96)	400-33945
N	3/4	19.1	(58)	400-25500	(71)	400-35895	(83)	400-25840	(97)	400-33947
P	7/8	22.2	(59)	400-25502	(72)	400-71913	(84)	400-25841	(98)	400-33949
Q	1	25.4	(60)	400-25503	(73)	400-71914	(85)	400-25842	(99)	400-33951
Stitch spec. 縫 仕 様			Type G G 仕 様							

Needle gauge size 針 幅			Sliding plate asm. (Left) 滑 り 板(左)組		Sliding plate asm. (Right) 滑 り 板(右)組		Sliding plate asm. (Front) 滑 り 板(前)組		Sliding plate asm. (Left) 滑 り 板(左)組	
Code コード									Option オプション 	
	inch	mm	No.	Part No.	No.	Part No.	No.	Part No.	No.	Part No.
B	1/8	3.2	(100)	400-25247	(103)	400-25235	(106)	400-42880	(107)	400-51633
C	5/32	4.0								
D	3/16	4.8								
E	7/32	5.6								
F	1/4	6.4								
G	9/32	7.1								
H	5/16	7.9								
K	3/8	9.5								
W	7/16	11.1								
L	1/2	12.7	(101)	400-25248	(104)	400-25236	(108)	400-45729		
M	5/8	15.9								
N	3/4	19.1								
P	7/8	22.2	(102)	400-25249	(105)	400-25239	(109)	400-45730		
Q	1	25.4								
Stitch spec. 縫 仕 様			Type G G 仕 様							

No.	品番	品名	備考	子部品	消耗品	個数
1	B1402528BA0A	NEEDLE CLAMP ASM. 1/8				1.00
2	B1402528CA0A	NEEDLE CLAMP ASM. 5/32				1.00
3	B1402528DALA	NEEDLE CLAMP ASM. LEFT				1.00
4	B1402528EAL	NEEDLE CLAMP ASM. 7/32				1.00
5	B1402528FALA	NEEDLE CLAMP ASM. 1/4				1.00
6	B1402528GAL	NEEDLE CLAMP ASM., LEFT				1.00
7	B1402528HALA	NEEDLE CLAMP ASM. 5/16				1.00
8	B1402528KALA	NEEDLE CLAMP ASM. 3/8				1.00
9	B1402528LAL	NEEDLE CLAMP ASM., LEFT 1/2				1.00
10	B1402528MAL	NEEDLE CLAMP ASM., LEFT 5/8				1.00
11	B1402528NAL	NEEDLE CLAMP ASM., LEFT 3/4				1.00
12	B1402528PAL	NEEDLE CLAMP ASM. LEFT 7/8				1.00
13	B1402528QAL	NEEDLE CLAMP ASM., LEFT 1				1.00
14	B1402528DARA	NEEDLE CLAMP ASM. RIGHT				1.00
15	B1402528EAR	NEEDLE CLAMP ASM. 7/32				1.00
16	B1402528FARA	NEEDLE CLAMP ASM. 1/4				1.00
17	B1402528GAR	NEEDLE CLAMP ASM., RIGHT				1.00
18	B1402528HARA	NEEDLE CLAMP ASM. 5/16				1.00
19	B1402528KARA	NEEDLE CLAMP ASM. 3/8				1.00
20	B1402528LAR	NEEDLE CLAMP ASM., RIGHT 1/2				1.00
21	B1402528MAR	NEEDLE CLAMP ASM., RIGHT 5/8				1.00
22	B1402528NAR	NEEDLE CLAMP ASM., RIGHT 3/4				1.00
23	B1402528PAR	NEEDLE CLAMP ASM. RIGHT 7/8				1.00
24	B1402528QAR	NEEDLE CLAMP ASM., RIGHT 1				1.00
25	B1402526BA0A	NEEDLE CLAMP ASM. 1/8				1.00
26	B1402526CA0A	NEEDLE CLAMP ASM. 5/32				1.00
27	B1402526DALA	NEEDLE CLAMP LEFT ASM. 3/16				1.00
28	10228559	NEEDLE CLAMP ASM. LEFT 7/32				1.00
29	B1402526FALA	NEEDLE CLAMP LEFT ASM. 1/4				1.00
30	B1402526GALA	NEEDLE CLAMP LEFT ASM. 9/32				1.00
31	B1402526HALA	NEEDLE CLAMP LEFT ASM. 5/16				1.00
32	B1402526KALA	NEEDLE CLAMP LEFT ASM. 3/8				1.00
33	B1402526LALA	NEEDLE CLAMP LEFT ASM.				1.00
34	10228856	NEEDLE CLAMP ASM. LEFT 5/8				1.00
35	10228955	NEEDLE CLAMP ASM. LEFT 3/4				1.00
36	10229151	NEEDLE CLAMP ASM. LEFT 1				1.00
37	B1402526DARA	NEEDLE CLAMP RIGHT ASM. 3/16				1.00
38	10228567	NEEDLE CLAMP ASM. RIGHT 7/32				1.00
39	B1402526FARA	NEEDLE CLAMP RIGHT ASM. 1/4				1.00
40	B1402526GARA	NEEDLE CLAMP RIGHT ASM. 9/32				1.00
41	B1402526HARA	NEEDLE CLAMP RIGHT ASM. 5/16				1.00
42	B1402526KARA	NEEDLE CLAMP RIGHT ASM. 3/8				1.00
43	B1402526LARA	NEEDLE CLAMP RIGHT ASM.				1.00
44	10228864	NEEDLE CLAMP ASM. RIGHT 5/8				1.00
45	10228963	NEEDLE CLAMP ASM. RIGHT 3/4				1.00
46	10229169	NEEDLE CLAMP ASM. RIGHT 1				1.00
47	40035881	THROAT_PLATE_TRIM_1/8				1.00
48	40025485	THROAT_PLATE_TRIM 5/32				1.00
49	40025490	THROAT_PLATE_TRIM-3/16				1.00
50	40025491	THROAT_PLATE_TRIM-7/32				1.00

51	40025492	THROAT_PLATE_TRIM-1/4				1.00
52	40025493	THROAT_PLATE_TRIM-9/32				1.00
53	40025494	THROAT_PLATE_TRIM-5/16				1.00
54	40025495	THROAT_PLATE_TRIM-3/8				1.00
55	40025496	THROAT_PLATE_TRIM-7/16				1.00
56	40025498	THROAT_PLATE_TRIM-1/2				1.00
57	40025499	THROAT_PLATE_TRIM-5/8				1.00
58	40025500	THROAT_PLATE_TRIM-3/4				1.00
59	40025502	THROAT_PLATE_TRIM-7/8				1.00
60	40025503	THROAT_PLATE_TRIM-1				1.00
61	40053705	FEED_DOG_TYPE_7G_1/8				1.00
62	40071911	FEED_DOG_7G_5/32				1.00
63	40035891	FEED_DOG_TYPE_7G_3/16				1.00
64	40050009	FEED_DOG_TYPE_7G_7/32				1.00
65	40035892	FEED_DOG_TYPE_7G_1/4				1.00
66	40050010	FEED_DOG_TYPE_7G_9/32				1.00
67	40050011	FEED_DOG_TYPE_7G_5/16				1.00
68	40035893	FEED_DOG_TYPE_7G_3/8				1.00
69	40035894	FEED_DOG_TYPE_7G_1/2				1.00
70	40071912	FEED_DOG_7G_5/8				1.00
71	40035895	FEED_DOG_TYPE_7G_3/4				1.00
72	40071913	FEED_DOG_7G_7/8				1.00
73	40071914	FEED_DOG_7G_1				1.00
74	40025831	FEED_DOG_TYPE_7G_3/16				1.00
75	40025832	FEED_DOG_TYPE_7G_7/32				1.00
76	40025833	FEED_DOG_TYPE_7G_1/4				1.00
77	40025834	FEED_DOG_TYPE_7G_9/32				1.00
78	40025835	FEED_DOG_TYPE_7G_5/16				1.00
79	40025836	FEED_DOG_TYPE_7G_3/8				1.00
80	40025837	FEED_DOG_TYPE_7G_7/16				1.00
81	40025838	FEED_DOG_TYPE_7G_1/2				1.00
82	40025839	FEED_DOG_TYPE_7G_5/8				1.00
83	40025840	FEED_DOG_TYPE_7G_3/4				1.00
84	40025841	FEED_DOG_TYPE_7G_7/8				1.00
85	40025842	FEED_DOG_TYPE_7G_1				1.00
86	40035896	PRESSER FOOT ASM.				1.00
87	40071909	PRESSER_FOOT_ASM_G_5/32				1.00
88	22816557	TIP-DIVIDED PRESSER ASM. 3/16				1.00
89	22816656	TIP-DIVIDED PRESSER ASM. 7/32				1.00
90	22816755	PRESSER FOOT ASM. 1/4				1.00
91	22816854	TIP-DIVIDED PRESSER ASM. 9/32				1.00
92	22816953	TIP-DIVIDED PRESSER ASM. 5/16				1.00
93	22817050	PRESSER FOOT ASM. D=2.4 (3/8)				1.00
94	40033941	TIP-DIVIDED_PRESSER_ASM_7/16				1.00
95	22817159	PRESSER FOOT ASM. D=2.4 (1/2)				1.00
96	40033945	TIP-DIVIDED_PRESSER_ASM_5/8				1.00
97	40033947	TIP-DIVIDED_PRESSER_ASM_3/4				1.00
98	40033949	TIP-DIVIDED_PRESSER_ASM_7/8				1.00
99	40033951	TIP-DIVIDED_PRESSER_ASM_1				1.00
100	40025247	ASSY_SLIDE_PLATE-L-A				1.00
101	40025248	ASSY_SLIDE_PLATE-L-B				1.00

102	40025249	ASSY_SLIDE_PLATE-L-C				1.00
103	40025235	ASSY_SLIDE_PLATE-R-A				1.00
104	40025236	ASSY_SLIDE_PLATE-R-B				1.00
105	40025239	ASSY_SLIDE_PLATE-R-C				1.00
106	40042880	ASSY_SLIDE_PLATE_F				1.00
107	40051633	ASSY_SLIDE_PLATE_L				1.00
108	40045729	ASSY_SIDE_PLATE-L-B				1.00
109	40045730	ASSY_SIDE_PLATE-L-C				1.00

# LIST FOR INFORMATION OF CHANGE (1)

As to the place changed, refer to the corresponding Rev.No.  
 When previous parts(Obsoleted part)and new parts(Added parts)are  
 not interchangeable with each other:  
 In this case, even obsoleted parts(D.)can be ordered with the  
 obsoleted part number, so select the parts with changed dates and  
 place your orders.

変更箇所は、該当Rev.No.版をご参照ください。

部品の互換性がない変更の場合は、削除された品番でも、ご注文できます。

40058960

No.1481-04・・・Rev.No.

\*A:Added parts追加部品/D:Obsoleted parts削除部品/E:Erratum訂正

* Rev. No.	Page 頁	Ref. No.	Parts No. 品番	* Rev. No.	Page 頁	Ref. No.	Parts No. 品番	
D	03	14	5	400-59784				
D	03	14	6	400-59785				
				A	04	14	30	101-12803
				A	04	14	31	226-88402
				A	04	14	32	226-88204
				A	04	14	35	400-12085
				A	04	14	36	226-12303
				A	04	14	37	400-36689
				A	04	14	38	101-12902
				A	04	14	39	226-12907
				A	04	14	40	101-10500
				A	04	14	42	400-36689
				A	04	14	43	400-12085
				A	04	14	44	110-15906
				A	04	14	45	226-88105
				A	04	14	47	400-12085
				A	04	14	48	110-15906
				A	04	14	49	400-36689
				A	04	14	51	101-12803
				A	04	14	52	226-12402
				A	04	14	53	400-36689
				A	04	14	54	400-12085
				A	04	14	56	226-12303
				A	04	14	57	101-10609
				A	04	14	58	101-10500
				A	04	14	59	101-12902
				A	04	16	37	228-13802
				A	04	16	38	101-10609
				A	04	16	39	101-10500
				A	04	16	40	400-12085
				A	04	16	41	400-18978
				A	04	16	42	101-12803
				A	04	16	43	228-14008
				A	04	16	44	228-13703
				A	04	16	48	228-27208
				A	04	16	49	228-27406



# HOW TO MAKE USE OF THIS PARTS LIST

## 1.Explanation of codes

1)"\*"mark.....means this part is changed from the previous parts book.

As to the details of the change, refer to the "List for information of change".

2)"#01".....refer to "Note" explanation at bottom of page.

## 2.Codes on the "Qty" column

· Each numeral indicates the number of parts required.

· "0.1" and "2.5" indicate the length (in meters) of the respective parts.

3.Parentheses mean that the corresponding part is a subpart that constructs an assembly part.

4.Dotted lines on the Figures indicate assembly parts.

5.As to the parts with marks of "☆"(consumable parts) and "◎"(optional parts)on the respective parts, it is recommended to prepare spares.

## 1 ."注記"欄の記号説明

1) "\*"印.....前回のパーツブックに比較して今回変更された部品を意味します。

変更内容は、"変更情報リスト"を参照してください。

2) "#01".....ページ下の"注記"の説明を参照してください。

2.数量欄の数字は、個数を表し、0.1、2.5等の数値は、長さ（単位メートル）を表します。

3.数量欄の（ ）は、組部品を構成している子部品であることを意味します。

4.イラストページの-----枠は、組構成であることを意味します。

5.リストページの"☆"（消耗部品）、"◎"（オプション部品）の印がついた部品は、予備を準備しておくことをお奨めします。